

## Aluminum Capacitors Radial Miniature, Low Impedance

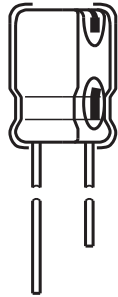
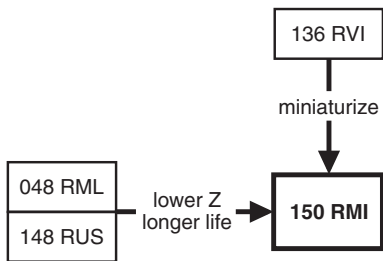

Fig.1 Component outline



### FEATURES

- Polarized aluminum electrolytic capacitors, non-solid electrolyte
- Radial leads, cylindrical aluminum case with pressure relief, insulated with a blue sleeve
- Charge and discharge proof
- Very long useful life: 4000 h to 10 000 h at 105 °C, high stability, high reliability
- Very low impedance or ESR respectively, at smaller case sizes than the 136 RVI series
- Excellent ripple current capability
- AEC-Q200 qualified
- Compliant to RoHS Directive 2002/95/EC



**RoHS**  
COMPLIANT

### APPLICATIONS

- Power supplies (SMPS, DC/DC converters) for general industrial, EDP, audio-video, automotive and telecommunications
- Smoothing, filtering, buffering

### QUICK REFERENCE DATA

DESCRIPTION	VALUE
Nominal case sizes (Ø D x L in mm)	8 x 12 to 18 x 31
Rated capacitance range, C <sub>R</sub>	100 µF to 6800 µF
Tolerance on C <sub>R</sub>	± 20 %
Rated voltage range, U <sub>R</sub>	10 V to 100 V
Category temperature range	- 55 °C to + 105 °C
Endurance test at 105 °C	3000 h to 5000 h
Useful life at 105 °C	4000 h to 10 000 h
Useful life at 40 °C, 1.8 x I <sub>R</sub> applied	200 000 h to 500 000 h
Shelf life at 0 V, 105 °C	1000 h
Based on sectional specification	IEC 60384-4/EN130300
Climatic category IEC 60068	55/105/56

### MARKING

The capacitors are marked (where possible) with the following information:

- Rated capacitance (in µF)
- Tolerance on rated capacitance, code letter in accordance with IEC 60062 (M for ± 20 %)
- Rated voltage (in V)
- Date code, in accordance with IEC 60062
- Code indicating factory of origin
- Name of manufacturer
- Upper category temperature (105 °C)
- Negative terminal identification
- Series number (150)

### SELECTION CHART FOR C<sub>R</sub>, U<sub>R</sub> AND RELEVANT NOMINAL CASE SIZES (Ø D x L in mm)

C <sub>R</sub> (µF)	U <sub>R</sub> (V)						
	10	16	25	35	50	63	100
22	-	-	-	-	-	-	8 x 12
47	-	-	-	-	-	8 x 12	-
100	-	-	-	8 x 12	-	10 x 12	-
150	-	-	-	-	10 x 12	10 x 16	-
220	-	8 x 12	8 x 12	8 x 15	10 x 16	10 x 20	-
	-	-	-	10 x 12	-	-	-
330	-	8 x 12	10 x 12	10 x 16	10 x 20	12.5 x 20	18 x 20
470	8 x 12	8 x 15	10 x 16	10 x 20	12.5 x 20	12.5 x 25	-
	-	10 x 12	-	-	-	16 x 20	-
680	10 x 12	10 x 16	10 x 20	12.5 x 20	12.5 x 25	16 x 20	-
	-	-	-	-	-	16 x 25	-
1000	10 x 16	10 x 20	12.5 x 20	12.5 x 25	16 x 25	16 x 31	-
	-	-	-	16 x 20	-	-	-

<b>SELECTION CHART FOR <math>C_R</math>, <math>U_R</math> AND RELEVANT NOMINAL CASE SIZES (<math>\varnothing D \times L</math> in mm)</b>							
$C_R$ ( $\mu F$ )	$U_R$ (V)						
	10	16	25	35	50	63	100
1200	-	-	-	-	16 x 31	-	-
1500	-	12.5 x 20	12.5 x 25	16 x 20	16 x 31	-	-
	-	-	-	12.5 x 35	-	-	-
2200	12.5 x 20	12.5 x 25	16 x 20	16 x 31	-	-	-
	-	-	12.5 x 35	-	-	-	-
3300	12.5 x 25	16 x 20	16 x 31	18 x 31	-	-	-
4700	16 x 25	16 x 31	16 x 35	-	-	-	-
6800	16 x 31	16 x 35	-	-	-	-	-

**DIMENSIONS in millimeters AND AVAILABLE FORMS**

Fig.2 Form CA: Long leads

Fig.3 Form CB: Cut leads

Fig.4 Form TFA: Taped in box (ammopack)

Table 1

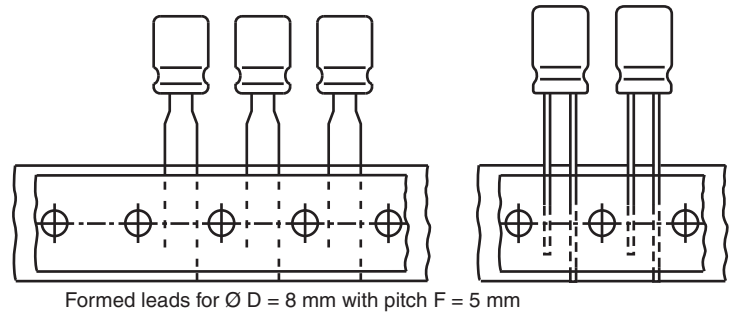
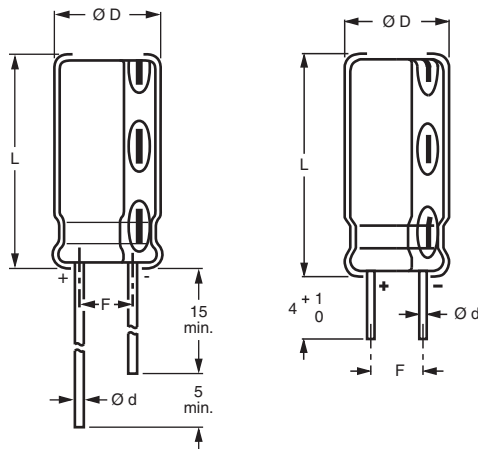
<b>DIMENSIONS in millimeters, MASS AND PACKAGING QUANTITIES</b>									
NOMINAL CASE SIZE $\varnothing D \times L$	CASE CODE	$\varnothing d$	$\varnothing D_{max.}$	$L_{max.}$	F	MASS (g)	PACKAGING QUANTITIES		
							FORM CA	FORM CB	FORM TFA
8 x 12	13	0.6	8.5	13.0	$3.5 \pm 0.5$	$\approx 1.1$	5000	5000	1000
8 x 15	13L	0.6	8.5	16.0	$3.5 \pm 0.5$	$\approx 1.3$	5000	5000	1000
10 x 12	14	0.6	10.5	13.5	$5.0 \pm 0.5$	$\approx 1.6$	1000	500	800
10 x 16	15	0.6	10.5	17.5	$5.0 \pm 0.5$	$\approx 1.9$	500	500	800
10 x 20	16	0.6	10.5	22.0	$5.0 \pm 0.5$	$\approx 2.2$	500	500	800
12.5 x 20	17	0.6	13.0	22.0	$5.0 \pm 0.5$	$\approx 4.0$	500	500	500
12.5 x 25	18	0.6	13.0	27.0	$5.0 \pm 0.5$	$\approx 5.0$	250	250	500
12.5 x 35	18LL	0.6	13.0	37.5	$5.0 \pm 0.5$	$\approx 6.0$	250	250	-
16 x 20	19a	0.8	16.5	22.0	$7.5 \pm 0.5$	$\approx 6.0$	250	250	250
16 x 25	19	0.8	16.5	27.0	$7.5 \pm 0.5$	$\approx 8.0$	250	250	250
16 x 31	20	0.8	16.5	33.5	$7.5 \pm 0.5$	$\approx 9.0$	100	100	250
16 x 35	21	0.8	16.5	37.5	$7.5 \pm 0.5$	$\approx 11.0$	100	100	-
18 x 20	1820	0.8	18.5	22.0	$7.5 \pm 0.5$	$\approx 8.0$	100	100	-
18 x 31	1831	0.8	18.5	33.5	$7.5 \pm 0.5$	$\approx 12.5$	100	100	-



ELECTRICAL DATA	
SYMBOL	DESCRIPTION
$C_R$	rated capacitance at 100 Hz , tolerance $\pm 20\%$
$I_R$	rated RMS ripple current at 100 kHz , 105 °C
$I_{L2}$	max. leakage current after 2 minutes at $U_R$
$\tan \delta$	max. dissipation factor at 100 Hz
$Z$	max. impedance at 100 kHz

Note

Unless otherwise specified, all electrical values in Table 2 apply at  $T_{amb} = 20\text{ °C}$ ,  $P = 86\text{ kPa}$  to  $106\text{ kPa}$ ,  $RH = 45\%$  to  $75\%$

Table 2

ELECTRICAL DATA AND ORDERING INFORMATION										
$U_R$ (V)	$C_R$ 100 Hz ( $\mu\text{F}$ )	NOMINAL CASE SIZE $\varnothing D \times L$ (mm)	$I_R$ 100 kHz 105 °C (mA)	$I_{L2}$ 2 min ( $\mu\text{A}$ )	$\tan \delta$ 100 Hz	$Z$ 100 kHz + 20 °C ( $\Omega$ )	$Z$ 100 kHz - 40 °C ( $\Omega$ )	ORDERING CODE MAL2150.....		
								BULK PACKAGING		TAPED
								FORM CA	FORM CB	FORM TFA
10	470	8 x 12	555	47	0.19	0.117	0.870	54471E3	84471E3	34471E3
	680	10 x 12	730	71	0.19	0.097	0.680	54681E3	64681E3	34681E3
	1000	10 x 16	950	103	0.19	0.066	0.460	54102E3	64102E3	34102E3
	2200	12.5 x 20	1460	223	0.21	0.037	0.260	54222E3	64222E3	34222E3
	3300	12.5 x 25	1950	333	0.21	0.029	0.200	54332E3	64332E3	34332E3
	4700	16 x 25	2390	473	0.23	0.022	0.150	54472E3	64472E3	34472E3
	6800	16 x 31	2890	683	0.25	0.019	0.130	54682E3	64682E3	34682E3
16	220	8 x 12	555	35	0.16	0.117	0.870	55221E3	85221E3	35221E3
	330	8 x 12	555	53	0.16	0.117	0.870	55331E3	85331E3	35331E3
	470	8 x 15	730	78	0.16	0.085	0.750	95475E3	95478E3	95473E3
	470	10 x 12	730	78	0.16	0.097	0.680	55471E3	65471E3	35471E3
	680	10 x 16	950	112	0.16	0.066	0.460	55681E3	65681E3	35681E3
	1000	10 x 20	1180	163	0.16	0.049	0.340	55102E3	65102E3	35102E3
	1500	12.5 x 20	1460	243	0.16	0.037	0.260	55152E3	65152E3	35152E3
	2200	12.5 x 25	1950	355	0.18	0.029	0.200	55222E3	65222E3	35222E3
	3300	16 x 20	1840	531	0.20	0.028	0.200	55332E3	65332E3	35332E3
25	4700	16 x 31	2890	755	0.22	0.019	0.130	55472E3	65472E3	35472E3
	6800	16 x 35	3100	1091	0.24	0.018	0.130	55682E3	65682E3	-
	220	8 x 12	555	55	0.14	0.117	0.870	56221E3	86221E3	36221E3
	330	10 x 12	730	86	0.14	0.097	0.680	56331E3	66331E3	36331E3
	470	10 x 16	950	121	0.14	0.066	0.460	56471E3	66471E3	36471E3
	680	10 x 20	1180	173	0.14	0.049	0.340	56681E3	66681E3	36681E3
	1000	12.5 x 20	1460	253	0.14	0.037	0.260	56102E3	66102E3	36102E3
	1500	12.5 x 25	1950	378	0.14	0.029	0.200	56152E3	66152E3	36152E3
	2200	12.5 x 35	2510	553	0.16	0.028	0.200	96225E3	96226E3	-
35	2200	16 x 20	1840	553	0.16	0.028	0.200	56222E3	66222E3	36222E3
	3300	16 x 31	2890	828	0.16	0.019	0.130	56332E3	66332E3	36332E3
	4700	16 x 35	3100	1178	0.18	0.018	0.130	56472E3	66472E3	-
	100	8 x 12	555	35	0.12	0.117	0.870	50101E3	80101E3	30101E3
	220	8 x 15	730	77	0.12	0.085	0.750	90225E3	90228E3	90223E3
	220	10 x 12	730	80	0.12	0.097	0.680	50221E3	60221E3	30221E3
	330	10 x 16	950	118	0.12	0.066	0.460	50331E3	60331E3	30331E3
	470	10 x 20	1180	167	0.12	0.049	0.340	50471E3	60471E3	30471E3
	680	12.5 x 20	1460	241	0.12	0.037	0.260	50681E3	60681E3	30681E3
50	1000	12.5 x 25	1950	353	0.12	0.029	0.200	50102E3	60102E3	30102E3
	1000	16 x 20	1840	353	0.12	0.028	0.200	90105E3	90106E3	90103E3
	1500	12.5 x 35	2510	528	0.12	0.028	0.200	90186E3	90187E3	-
	1500	16 x 20	1840	528	0.12	0.028	0.200	50152E3	60152E3	30152E3
	2200	16 x 31	2890	773	0.14	0.019	0.130	50222E3	60222E3	30222E3
	3300	18 x 31	3000	1155	0.16	0.019	0.130	50332E3	60332E3	-
	150	10 x 12	500	78	0.10	0.200	1.400	51151E3	61151E3	31151E3
	220	10 x 16	700	113	0.10	0.120	0.840	51221E3	61221E3	31221E3
	330	10 x 20	900	168	0.10	0.090	0.630	51331E3	61331E3	31331E3
50	470	12.5 x 20	1100	238	0.10	0.062	0.430	51471E3	61471E3	31471E3
	680	12.5 x 25	1400	343	0.10	0.048	0.340	51681E3	61681E3	31681E3
	1000	16 x 25	1800	503	0.10	0.034	0.240	51102E3	61102E3	31102E3
	1200	16 x 31	2200	603	0.10	0.027	0.190	51122E3	61122E3	31122E3
	1500	16 x 31	2200	753	0.10	0.027	0.190	51152E3	61152E3	31152E3

ORDERING EXAMPLE

Electrolytic capacitor 150 series

470  $\mu\text{F}$ /16 V;  $\pm 20\%$

Nominal case size:  $\varnothing 10\text{ mm} \times 12\text{ mm}$ ; Form TFA

Ordering Code: MAL215035471E3

Former 12NC: 2222 150 35471



ELECTRICAL DATA AND ORDERING INFORMATION										
U <sub>R</sub> (V)	C <sub>R</sub> 100 Hz (µF)	NOMINAL CASE SIZE Ø D x L (mm)	I <sub>R</sub> 100 kHz 105 °C (mA)	I <sub>L2</sub> 2 min (µA)	tan δ 100 Hz	Z 100 kHz + 20 °C (Ω)	Z 100 kHz - 40 °C (Ω)	ORDERING CODE MAL2150.....		
								BULK PACKAGING		TAPED
								FORM CA	FORM CB	FORM TFA
63	47	8 x 12	405	30	0.09	0.342	2.350	58479E3	88479E3	38479E3
	100	10 x 12	420	66	0.10	0.270	1.890	58101E3	68101E3	38101E3
	150	10 x 16	560	97	0.10	0.190	1.330	58151E3	68151E3	38151E3
	220	10 x 20	700	141	0.10	0.150	1.050	58221E3	68221E3	38221E3
	330	12.5 x 20	930	211	0.10	0.095	0.670	58331E3	68331E3	38331E3
	470	12.5 x 25	1200	299	0.10	0.067	0.470	58471E3	68471E3	38471E3
	470	16 x 20	1100	299	0.10	0.074	0.520	98475E3	98476E3	98473E3
	680	16 x 20	1100	431	0.10	0.074	0.520	58681E3	68681E3	38681E3
	680	16 x 25	1500	431	0.10	0.054	0.380	98685E3	98686E3	98683E3
	1000	16 x 31	1900	633	0.10	0.042	0.295	58102E3	68102E3	38102E3
100	22	8 x 12	230	22	0.08	0.68	27.0	59229E3	89229E3	39229E3
	330	18 x 20	1700	330	0.07	0.074	2.0	90183E3	90185E3	-

ADDITIONAL ELECTRICAL DATA		
PARAMETER	CONDITIONS	VALUE
<b>Voltage</b>		
Surge voltage		U <sub>s</sub> ≤ 1.15 x U <sub>R</sub>
Reverse voltage		U <sub>rev</sub> ≤ 1 V
<b>Current</b>		
Leakage current	After 2 minutes at U <sub>R</sub>	I <sub>L2</sub> ≤ 0.01 C <sub>R</sub> x U <sub>R</sub> + 3 µA
<b>Inductance</b>		
Equivalent series inductance (ESL)	Case Ø D ≤ 10 mm	typ. 16 nH
	Case Ø D ≥ 12.5 mm	typ. 18 nH
<b>Resistance</b>		
Equivalent series resistance (ESR)	Calculated from tan δ <sub>max</sub> and C <sub>R</sub> (see Table 2)	ESR = tan δ/2 π f C <sub>R</sub>

**CAPACITANCE (C)**

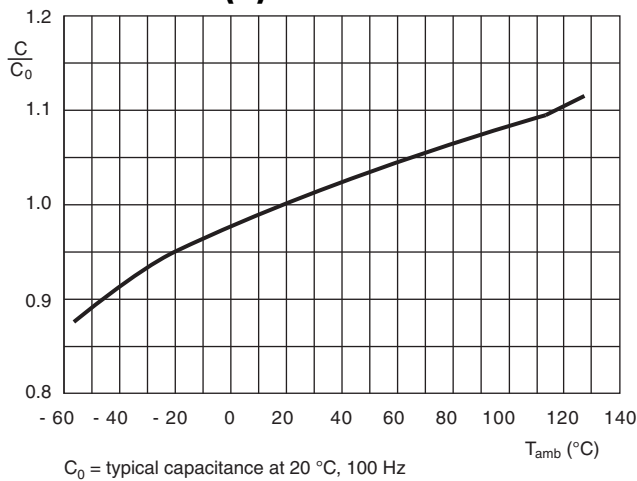

Fig.5 Typical multiplier of capacitance as a function of ambient temperature

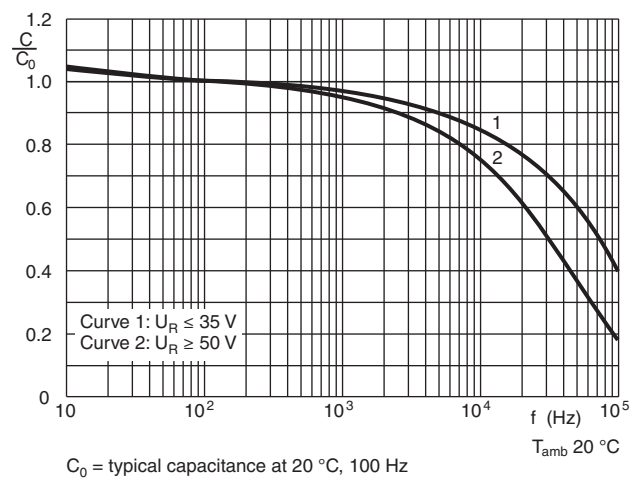

Fig.6 Typical multiplier of capacitance as a function of frequency

**EQUIVALENT SERIES RESISTANCE (ESR)**

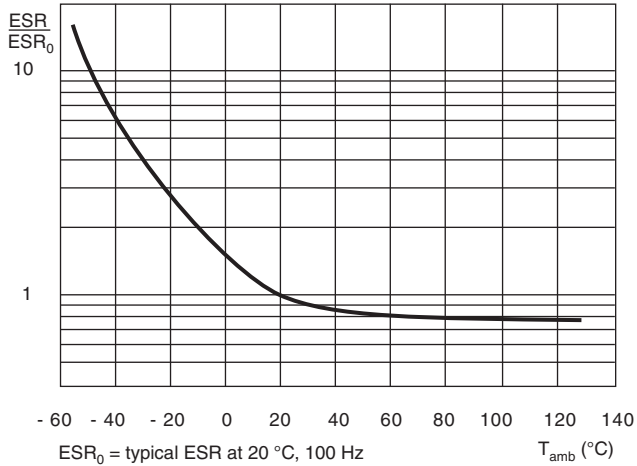

Fig.7 Typical multiplier of ESR as a function of ambient temperature

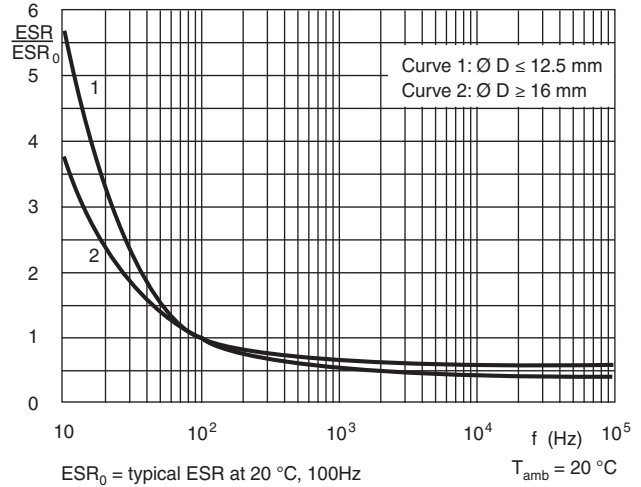

Fig.8 Typical multiplier of ESR as a function of frequency

**IMPEDANCE (Z)**

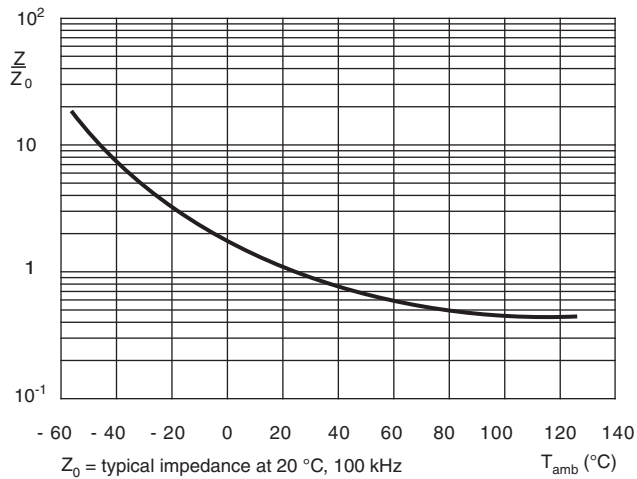

Fig.9 Typical multiplier of impedance as a function of ambient temperature

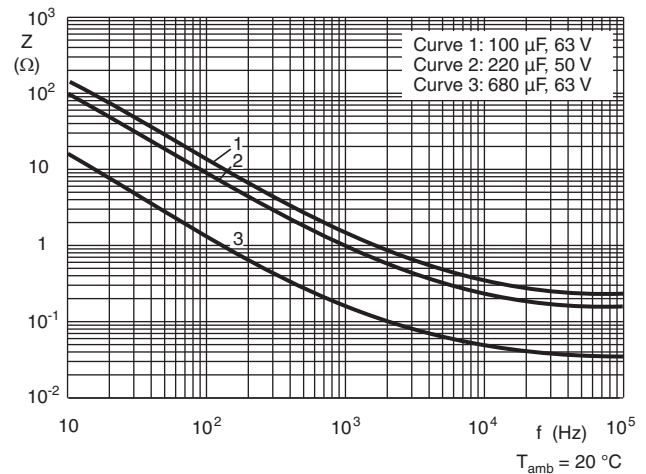

Fig.11 Typical impedance as a function of frequency

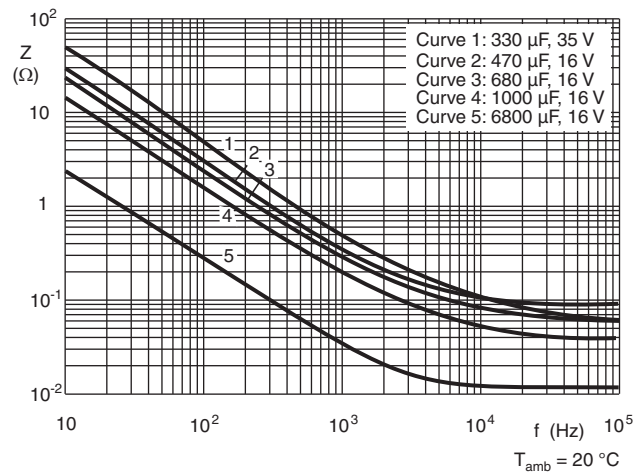
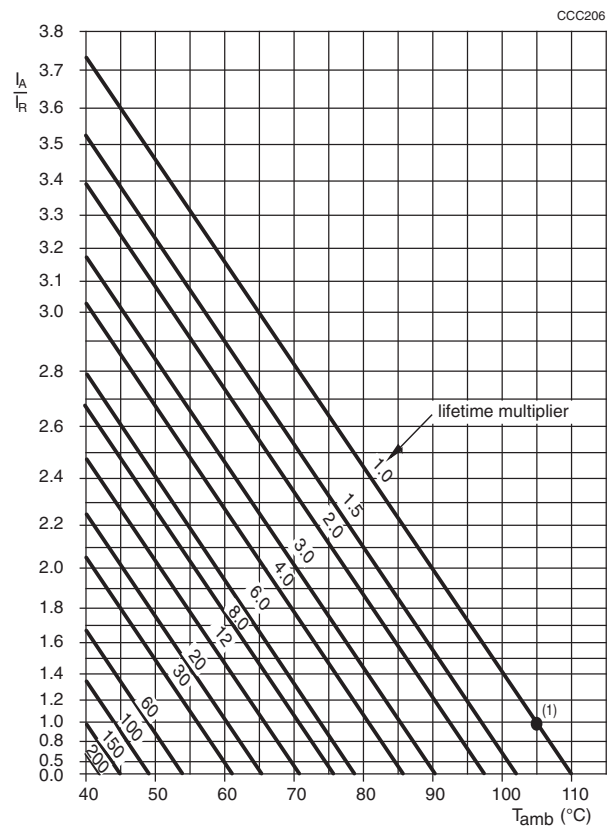

Fig.10 Typical impedance as a function of frequency

**RIPPLE CURRENT AND USEFUL LIFE**

Table 3

<b>ENDURANCE TEST DURATION AND USEFUL LIFE AS A FUNCTION OF CASE SIZE</b>			
NOMINAL CASE SIZE Ø D x L (mm)	CASE CODE	ENDURANCE at 105 °C (h)	USEFUL LIFE at 105 °C (h)
8 x 12	13	3000	4000
8 x 15	13L	3000	4000
10 x 12	14	3000	4000
10 x 16	15	3000	6000
10 x 20	16	3000	6000
12.5 x 20	17	3000	7000
12.5 x 25	18	5000	8000
12.5 x 35	18LL	5000	8000
16 x 20	19a	3000	7000
16 x 25	19	5000	10 000
16 x 31	20	5000	10 000
16 x 35	21	5000	10 000
18 x 20	1820	3000	7000
18 x 31	1831	6000	10 000



$I_A$  = actual ripple current at 100 kHz  
 $I_R$  = rated ripple current at 100 kHz, 105 °C  
 (1) Useful life at 105 °C and  $I_R$  applied; see Table 4

Fig.12 Multiplier of useful life as a function of ambient temperature and ripple current load

Table 4

MULTIPLIER OF RIPPLE CURRENT ( $I_R$ ) AS A FUNCTION OF FREQUENCY		
FREQUENCY (Hz)	$I_R$ MULTIPLIER	
	$\varnothing = 8 \text{ mm to } 12.5 \text{ mm}$	$\varnothing = 16 \text{ mm and } 18 \text{ mm}$
100	0.65	0.76
300	0.76	0.85
1000	0.85	0.91
3000	0.89	0.94
10 000	0.90	0.96
30 000	0.97	0.98
100 000	1.00	1.00

Table 5

TEST PROCEDURES AND REQUIREMENTS			
TEST		PROCEDURE (quick reference)	REQUIREMENTS
NAME OF TEST	REFERENCE		
Endurance	IEC 60384-4/ EN130300 subclause 4.13	$T_{amb} = 105 \text{ }^\circ\text{C}$ ; $U_R$ applied; for test duration see Table 3	$\Delta C/C: \pm 20 \%$ $\tan \delta \leq 2 \times \text{spec. limit}$ $I_{L2} \leq \text{spec. limit}$
Useful life	CECC 30301 subclause 1.8.1	$T_{amb} = 105 \text{ }^\circ\text{C}$ ; $U_R$ and $I_R$ applied; for test duration see Table 3	$\Delta C/C: \pm 30 \%$ $\tan \delta \leq 3 \times \text{spec. limit}$ $I_{L2} \leq \text{spec. limit}$ no short or open circuit total failure percentage: $\leq 1 \%$
Shelf life (storage at high temperature)	IEC 60384-4/ EN130300 subclause 4.17	$T_{amb} = 105 \text{ }^\circ\text{C}$ ; no voltage applied; 1000 h after test: $U_R$ to be applied for 30 min., 24 h to 48 h before measurement	$\Delta C/C: \pm 20 \%$ $\tan \delta \leq 2 \times \text{spec. limit}$ $I_{L2} \leq \text{spec. limit}$



## Disclaimer

ALL PRODUCT, PRODUCT SPECIFICATIONS AND DATA ARE SUBJECT TO CHANGE WITHOUT NOTICE TO IMPROVE RELIABILITY, FUNCTION OR DESIGN OR OTHERWISE.

Vishay Intertechnology, Inc., its affiliates, agents, and employees, and all persons acting on its or their behalf (collectively, "Vishay"), disclaim any and all liability for any errors, inaccuracies or incompleteness contained in any datasheet or in any other disclosure relating to any product.

Vishay makes no warranty, representation or guarantee regarding the suitability of the products for any particular purpose or the continuing production of any product. To the maximum extent permitted by applicable law, Vishay disclaims (i) any and all liability arising out of the application or use of any product, (ii) any and all liability, including without limitation special, consequential or incidental damages, and (iii) any and all implied warranties, including warranties of fitness for particular purpose, non-infringement and merchantability.

Statements regarding the suitability of products for certain types of applications are based on Vishay's knowledge of typical requirements that are often placed on Vishay products in generic applications. Such statements are not binding statements about the suitability of products for a particular application. It is the customer's responsibility to validate that a particular product with the properties described in the product specification is suitable for use in a particular application. Parameters provided in datasheets and/or specifications may vary in different applications and performance may vary over time. All operating parameters, including typical parameters, must be validated for each customer application by the customer's technical experts. Product specifications do not expand or otherwise modify Vishay's terms and conditions of purchase, including but not limited to the warranty expressed therein.

Except as expressly indicated in writing, Vishay products are not designed for use in medical, life-saving, or life-sustaining applications or for any other application in which the failure of the Vishay product could result in personal injury or death. Customers using or selling Vishay products not expressly indicated for use in such applications do so at their own risk and agree to fully indemnify and hold Vishay and its distributors harmless from and against any and all claims, liabilities, expenses and damages arising or resulting in connection with such use or sale, including attorneys fees, even if such claim alleges that Vishay or its distributor was negligent regarding the design or manufacture of the part. Please contact authorized Vishay personnel to obtain written terms and conditions regarding products designed for such applications.

No license, express or implied, by estoppel or otherwise, to any intellectual property rights is granted by this document or by any conduct of Vishay. Product names and markings noted herein may be trademarks of their respective owners.