

## LSK-120001Ax (x for Actuator Length)

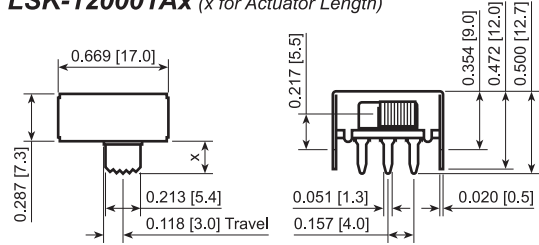

## Suggested PCB Layout

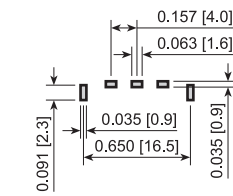

## Electrical Schematic

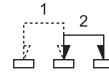

## FEATURES:

- Compact Size With Multiple Functions
- RoHS and Lead Free Compliant
- Customizable Actuator Height

## SPECIFICATIONS:

**RATING:** 0.5A 50VDC  
**TEMPERATURE:** -30°C to 105°C  
**ELECTRICAL LIFE:** 10,000 Cycles  
**CONTACT RESISTANCE:** 30mΩ Max.  
**INSULATION RESISTANCE:** 500MΩ Min. at 500VDC  
**DIELECTRIC STRENGTH:** 500VAC for 1 Minute

## MATERIALS:

**Body:** Steel  
**ACTUATOR:** Polyoxymethylene  
**Base:** Phenolic Board  
**CONTACTS:** Silver Plated Copper  
**TERMINALS:** Silver Plated Brass

## LSK-220001Ax (x for Actuator Length)

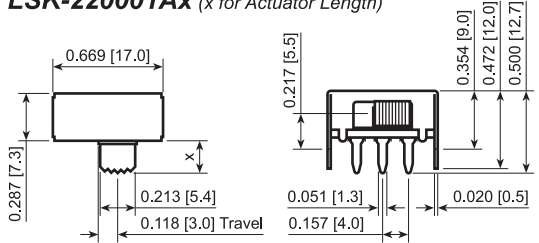

## Suggested PCB Layout

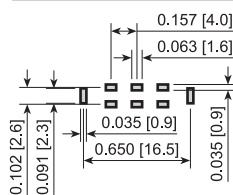

## Electrical Schematic

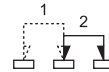

## LSK-130101Ax (x for Actuator Length)

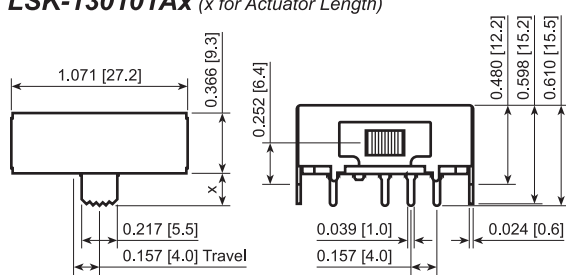

## Suggested PCB Layout

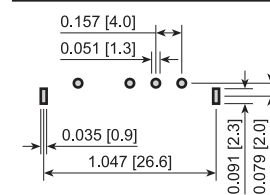

## Electrical Schematic

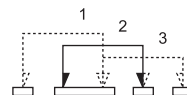

## LSK-230101Ax (x for Actuator Length)

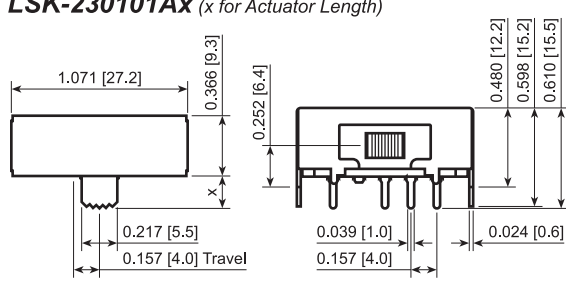

## Suggested PCB Layout

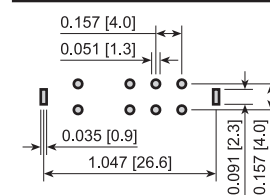

## Electrical Schematic

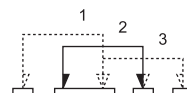

LSK-220001A7



LSK-230101A7

| Series          | Number of Poles / Positions                                     | Model                                | Terminal Type | Actuator Type         | Actuator Height                               |
|-----------------|---|--------------------------------------|---------------|-----------------------|---|
| LSK - Side Knob | For Model 00:<br>12 - 1 Pole, On-On<br>22 - 2 Pole, On-On       | 000 - 17.0 x 7.3<br>010 - 27.2 x 9.3 | 1 - PCB Pin   | A - Rounded<br>Ridged | 5 - 5mm (Standard)<br>X - Varies From 2 to 20 |
|                 | For Model 01:<br>13 - 1 Pole, On-On-On<br>23 - 2 Pole, On-On-On |                                      |               |                       |   |

## EXAMPLE PART NUMBERS:

- LSK-120001A5 1P2T On-On  
Model 000, PCB Pins, 5.0mm Actuator
- LSK-130101A5 1P3T On-On-On  
Model 010, PCB Pins, 5.0mm Actuator
- LSK-220001A5 2P2T On-On  
Model 000, PCB Pins, 5.0mm Actuator
- LSK-230101A5 2P3T On-On-On  
Model 010, PCB Pins, 5.0mm Actuator