

GENERAL PURPOSE, HI-K (DIELECTRIC CONSTANT Class II/III) TYPE

FEATURES

- WIDE SELECTION OF TEMPERATURE CHARACTERISTICS
- HIGH INSULATION RESISTANCE
- EXCELLENT HIGH FREQUENCY CHARACTERISTICS
- ECONOMICALLY PRICED
- AVAILABLE WITH FORMED LEADS AND ON TAPE FOR AUTOMATIC INSERTION

*See Part Number System for Details



SPECIFICATIONS

Temperature Characteristics		Y5F	Y5P	Z5U	Z5V
Operating Temperature Range		-30°C ~ +85°C	-30°C ~ +85°C	+10°C ~ +85°C	+10°C ~ +85°C
Capacitance Range		100pF ~ 0.01μF	100pF ~ 0.022μF	0.001μF ~ 0.01μF	0.001μF ~ 0.1μF
Standard Tolerance		±10% (K)	±10% (K)	±20% (M)	+80%/-20% (Z)
Capacitance Change Over Temperature Range		±7.5%	±10%	-55% ~ +22	-82% ~ +22%
Dissipation Factor		2.5%*	2.5%*	5%	5%
Insulation Resistance		Minimum 10,000 Megohms			
Working Voltage Range		50Vdc ~ 1KVdc			
Dielectric Withstanding Voltage (Test Voltage)		2.5 Times Rated Voltage For Not Less Than 1 Second, 50mA Maximum			
Load Life Test @ 85°C 1,000 Hours	Cap. Change	±10%	±10%	±20%	±30%
	D.F. (max.)	4%	4%	7.5%	7.5%
	I.R. (min.)	1,000 Megohms			
Test Conditions		1KHz, 1.0V ±0.2Vrms		1KHz, 0.5V ± 0.1Vrms	

* Special low dissipation factor (1.0% max.) Y5F and Y5P dielectrics are also available. Contact NIC for availability.

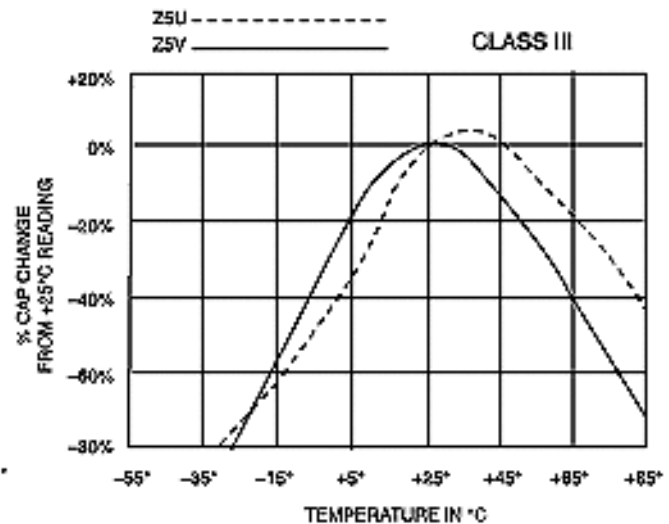
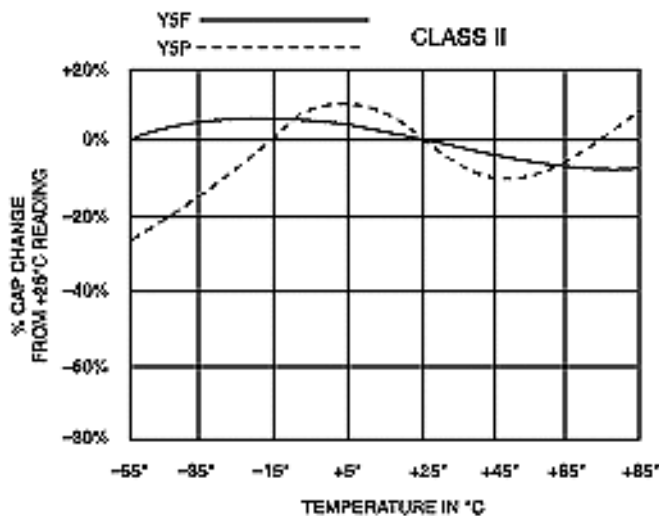

Ceramic Disc Capacitors

NCD Series Class II/III

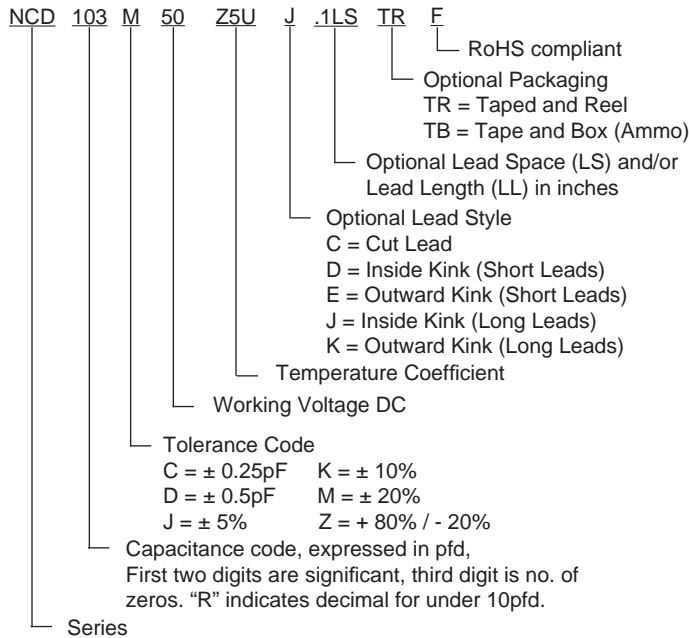

Lead Spacing (mm) - S				
Body Diameter	Standard Bulk	Standard T&R	Optional Bulk mm (inches)	Optional T&R mm (inches)
5 ~ 11	6.35 \pm 0.8	5.0 \pm 0.8	5.0 \pm 0.8 (0.2LS)	2.5 \pm 0.8 (0.1LS)
≥ 12	6.35 \pm 0.8	5.0 \pm 0.8	7.5 \pm 0.8 (0.295LS)	7.5 \pm 0.8 (0.295LS)
			10.0 \pm 0.8 (0.395LS)	10.0 \pm 0.8 (0.395LS)

LEAD DIAMETER
0.6MM IS STANDARD

BODY THICKNESS
2 ~ 4MM DEPENDENT ON CV

Standard
500Vdc & Up

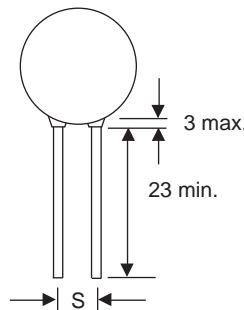

Low Voltage
100Vdc & Below

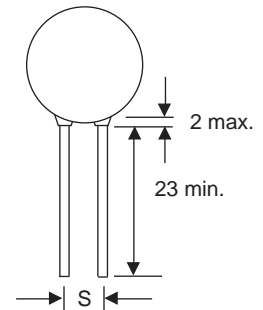

STANDARD PRODUCTS AND MAXIMUM DIAMETER (mm) BY T.C. AND VOLTAGE

Cap. (pF/ μF)	Y5F/Y5P*			Z5U			Z5V		
	Working Voltage (Vdc)								
	50 100	500	1K	50 100	500	1K	50 100	500	1K
100~470pF	6	6	6	-	-	-	-	-	-
560	6	6	6	-	-	-	-	-	-
680	6	6	7	-	-	-	-	-	-
750	6	6	7	-	-	-	-	-	-
820	6	6	7	-	-	-	-	-	-
0.001 μF	6	7	7	6	6	6	-	6	6
0.0015	6	8	8	6	6	7	-	6	6
0.0022	6	9	10	6	7	7	6	6	6
0.0027	7	10	12	6	7	8	6	6	7
0.0033	7	10	14	6	7	9	6	7	8
0.0047	8	12	14	6	8	10	6	8	8
0.0056	9	14	16	6	9	10	6	8	9
0.0068	9	14	16	7	9	12	6	8	10
0.0082	10	16	18	7	10	12	6	9	10
0.01	12	16	20	7	10	12	6	9	10
0.015	14	21	-	9	14	16	7	10	12
0.022	-	-	-	10	16	18	8	14	16
0.033	-	-	-	8	18	22	7	16	18
0.047	-	-	-	8	21	24	7	16	21
0.068	-	-	-	8/9	24	-	8	16	-
0.1	-	-	-	8/9	26	-	8/9	17	-

*.0047 μF AND ABOVE NOT AVAILABLE IN Y5F, PLEASE USE Y5P.
NIC RESERVES THE RIGHT TO REQUEST MINIMUM QUANTITIES ON CERTAIN VALUES.

J Style

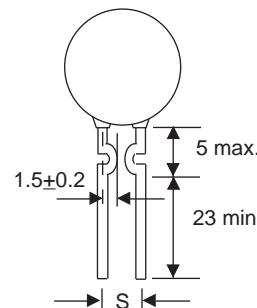

K Style

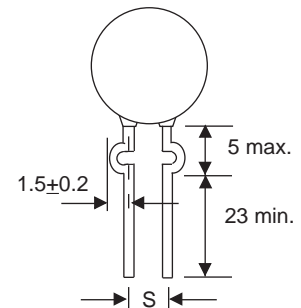

(BULK AND TAPED STYLES)

D Style

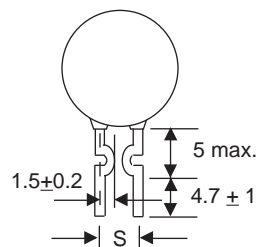

E Style

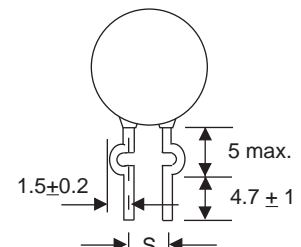

(BULK ONLY)



Ceramic Disc Capacitors

Taping Specifications

DIMENSIONS (mm)

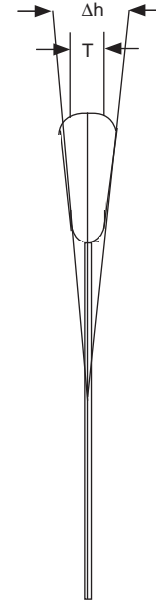
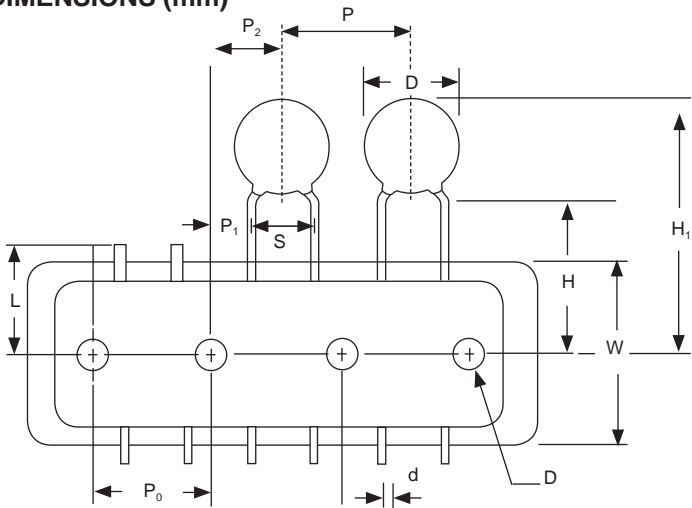

Diameters up to 22mm max. are available on tape.

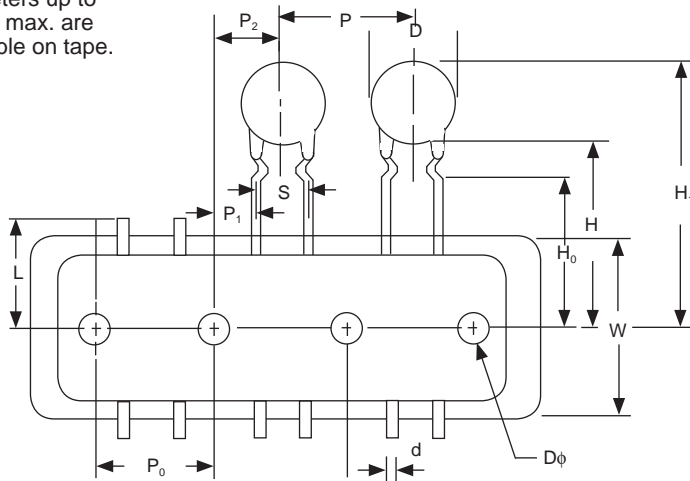

T = 2 ~ 7mm DEPENDENT ON T.C. AND CV

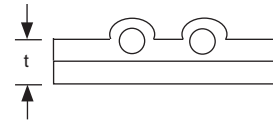

Symbol	D max.	d	P*	P ₀	P ₁	P ₂	S	H	H ₀	H ₁	Dφ	W	L	t	Δh
Value	12.0 22.0	0.6	12.7 25.4	12.7	5.1 3.85 3.18 2.6	6.35	2.5 5.0 6.35 7.5	20.0	16.0	Max. 32.25	4.0	18.0	Max. 11.00	0.7	0
Tolerance	---	+0.06 -0.05	±1.0	±0.2	±0.7	±1.0	±0.8 -0.2	+1.5 -1.0	±0.5	---	±0.2	±0.5	---	±0.2	±2.0

* -Dimension "P" is 12.7mm, for diameters up to 12mm, and 25.4mm for diameters 13-22mm.

AMMO PACK

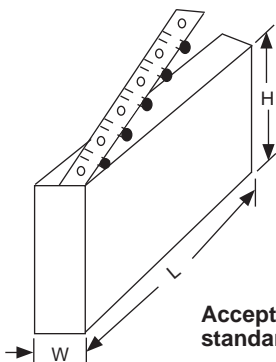

H ≤ 372 (14.64")
L ≤ 377 (14.84")
W ≤ 55 (2.16")

Acceptable to standard radial type cartridge.

REEL

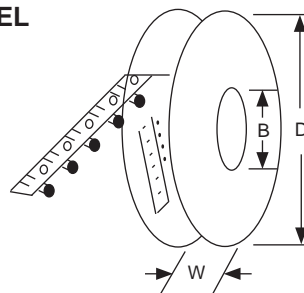

D ≤ 354 (13.93")
B ≥ 21 (.83") but
≤ 30 (1.18")
W ≤ 55 (2.16")

Acceptable to standard radial type cartridge with a few extra accessories.

