

FEATURES

- **GOLD INNER ELECTRODE FOR SUPERIOR ANTI-CORROSION PROPERTIES**
- EIA STANDARD SIZING 0402, 0603, 0805, 1206, 1210, 2010 AND 2512
- SUIT FOR HIGH RELIABILITY APPLICATIONS IN HARSH ENVIRONMENTS
- ALL SIZES ARE AVAILABLE IN TAPE/REEL FOR AUTOMATIC MOUNTING
- SAC REFLOW SOLDERABLE (THREE TIMES AT 260°C FOR 10 SECONDS)

RoHS Compliant
includes all homogeneous materials

*See Part Number System for Details



SPECIFICATIONS

Type	EIA Size	Power Rating at 70°C	Max. *1 Working Voltage	Max. *2 Overload Voltage	Resistance Tolerance Code	Temperature Coefficient (ppm/°C)	Resistance Range (Ω)*3	Resistance Values	Operating Temperature Range
NRCS04	0402	0.063W	50V	100V	±1%(F), ±2%(G), ±5%(J)	±200	10 ~ 1M	E-24 & E-96	-55°C ~ +155°C
						±350	3.9 ~ 9.1 1.1M ~ 22M		
						0 ~ +600	1.0 ~ 3.6		
NRCS06	0603	0.10W	50V	100V	±1%(F), ±2%(G), ±5%(J)	±100	10 ~ 1M	E-24 & E-96	
						±200	10 ~ 1M	E-24	
						±350	1.0 ~ 9.1 1.1M ~ 22M	E-24 & E96	
NRCS10	0805	0.125W	150V	300V	±1%(F), ±2%(G), ±5%(J)	±100	10 ~ 1M	E-24 & E-96	
						±200	10 ~ 1M	E-24	
						±250	3.9 ~ 9.1 1.1M ~ 5.1M	E-24 & E96	
NRCS12	1206	0.25W	200V	400V	±1%(F), ±2%(G), ±5%(J)	±350	1.0 ~ 3.6 5.6M ~ 22M	E-24 & E96	
						±100	10 ~ 1M	E-24 & E-96	
						±200	10 ~ 1M	E-24	
NRCS25	1210	0.25W	200V	400V	±1%(F), ±2%(G), ±5%(J)	±250	3.9 ~ 9.1 1.1M ~ 5.1M	E-24 & E96	
						±100	10 ~ 1M	E-24 & E-96	
						±200	10 ~ 1M	E-24	
NRCS50	2010	0.50W	200V	400V	±1%(F), ±2%(G), ±5%(J)	±250	3.9 ~ 9.1	E-24 & E96	
						±350	1.0 ~ 3.6	E-24 & E96	
						±100	10 ~ 1M	E-24 & E-96	
NRCS100	2512	1.0W	200V	400V	±1%(F), ±2%(G), ±5%(J)	±200	10 ~ 1M	E-24	
						±250	2.2 ~ 9.1	E-24 & E96	
						±350	1.0 ~ 2.0	E-24 & E96	

Note *1 - Maximum allowable continuous Working Voltage for all resistors is the lower of the two values:

"Maximum Working Voltage" as specified above or the result of the following formula

$$\sqrt{\text{Power rating (Watts)} \times \text{Resistance (Ohms)}}$$

Note *2 - "Maximum Overload Voltage" for all resistors is the lower of the two values:

"Maximum Overload Voltage" as specified above or 2x the result of the following formula

$$\sqrt{\text{Power rating (Watts)} \times \text{Resistance (Ohms)}}$$

Note *3 - 11Meg ~ 22Meg only available in E-24 values

Power Derating Curve: For operation above 70°C, power rating must be derated according to the following chart:

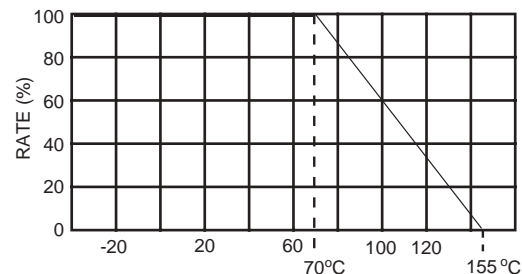

ZERO OHM JUMPER RATINGS

Jumper	EIA Size	Power Rating at 70°C	Current Rating	Overload Current Rating	Maximum Resistance	Operating Temperature Range
NRCS04ZO	0402	0.063W	1.0A	2.0A	50mΩ	-55°C ~ +155°C
NRCS06ZO	0603	0.10W	1.0A	2.0A		
NRCS10ZO	0805	0.125W	2.0A	4.0A		
NRCS12ZO	1206	0.25W				
NRCS25ZO	1210	0.25W				
NRCS50ZO	2010	0.50W	2.5A	5.0A		
NRCS100ZO	2512	1.0W				

Typical Performance*
(After immersions in cutting fluid with 0.5% Sulfur content)

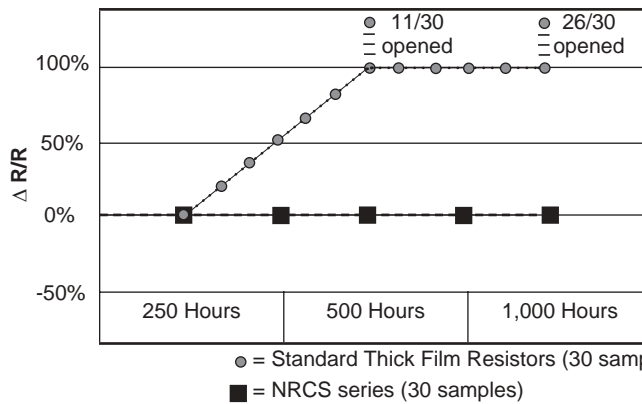

*Referential performance measured under certain preconditions and not guaranteed.

PART NUMBER SYSTEM (E-24 VALUES)

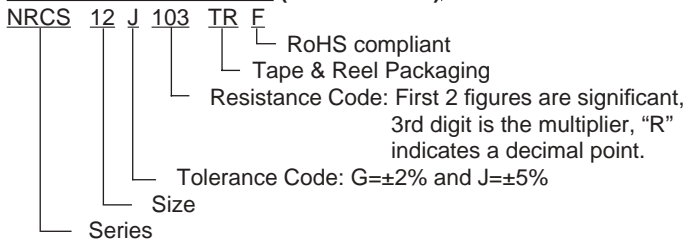

PART NUMBER SYSTEM (E-96 VALUES)

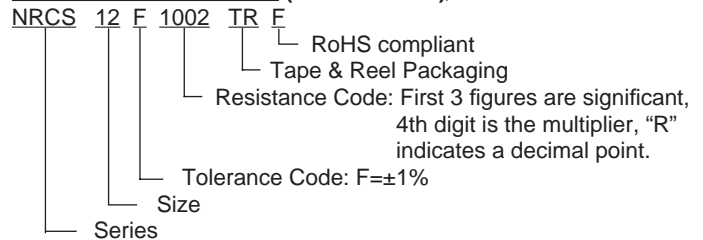

DIMENSIONS (mm)

Type	EIA Size	L	W	H	T	t
NRCS04	0402	1.0 ± 0.05	0.50 ± 0.05	0.35 ± 0.05	0.2 ± 0.1	0.25 ^{+0.06} _{-0.05}
NRCS06	0603	1.60 ± 0.15	0.80 ± 0.15	0.45 ± 0.10	0.30 ± 0.20	0.30 ± 0.20
NRCS10	0805	2.00 ± 0.20	1.25 ± 0.10	0.50 ± 0.10	0.40 ± 0.20	0.40 ± 0.20
NRCS12	1206	3.20 ^{+0.06} _{-0.05}	1.60 ^{+0.05} _{-0.15}	0.60 ± 0.10	0.50 ± 0.25	0.50 ± 0.20
NRCS25	1210	3.2 ± 0.20	2.50 ^{+0.2} _{-0.1}	0.60 ± 0.10	0.50 ± 0.25	0.50 ± 0.20
NRCS50	2010	5.0 ± 0.2	2.5 ± 0.15	0.6 ± 0.1	0.6 ± 0.2	0.5 ± 0.3
NRCS100	2512	6.3 ± 0.2	3.2 ± 0.2	0.6 ± 0.1	0.7 ± 0.2	0.7 ± 0.2

CONSTRUCTION

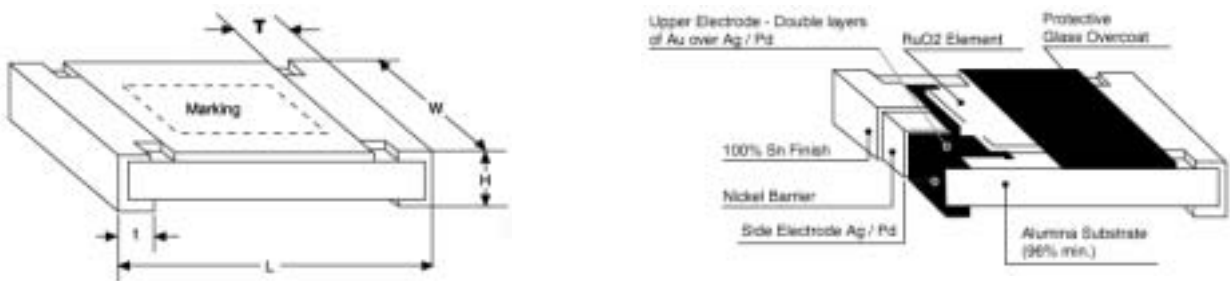

STANDARD E-12, E-24, E-96 VALUES AND 0603 RESISTANCE CODES

E-12		E-24		E-96											
Value		Value		Value	Code	Value	Code	Value	Code	Value	Code	Value	Code		
10		100		100	01	102	02	105	03	107	04	107	04		
12		110		110	05	113	06	115	07	118	08	118	08		
15		120		121	09	124	10	127	11	130	12	130	12		
18		130		133	13	137	14	140	15	143	16	143	16		
22		150		147	17	150	18	154	19	158	20	158	20		
27		160		162	21	165	22	169	23	174	24	174	24		
33		180		178	25	182	26	187	27	191	28	191	28		
39		200		196	29	200	30	205	31	210	32	210	32		
47		220		215	33	221	34	226	35	232	36	232	36		
56		240		237	37	243	38	249	39	255	40	255	40		
68		270		261	41	267	42	274	43	280	44	280	44		
82		300		287	45	294	46	301	47	309	48	309	48		
91		330		316	49	324	50	332	51	340	52	340	52		
		360		348	53	357	54	365	55	374	56	374	56		
		390		383	57	392	58	402	59	412	60	412	60		
		430		422	61	432	62	442	63	453	64	453	64		
		470		464	65	475	66	487	67	499	68	499	68		
		510		511	69	523	70	536	71	549	72	549	72		
		560		562	73	576	74	590	75	604	76	604	76		
		620		619	77	634	78	649	79	665	80	665	80		
		680		681	81	698	82	715	83	732	84	732	84		
		750		750	85	768	86	787	87	806	88	806	88		
		820		825	89	845	90	866	91	887	92	887	92		
		910		909	93	931	94	953	95	976	96	976	96		

CARRIER TAPE DIMENSIONS (mm)

Type	EIA Case Size	Carrier Material	A	B	W	F	E	P ₁	P ₂	P ₀	D ₀	t ₂	t ₁
NRCS04	0402	Paper	0.65 ±0.10	1.15 ±0.10	8.0 ±0.20	3.50 ±0.05	1.75 ±0.05	2.00 ±0.05	n/a	4.00 ±0.10	1.50 ^{+0.10} ₋₀	1.00 max.	0.5 max
NRCS06	0603		1.10 ±0.20	1.90 ±0.20				4.00 ±0.10	2.00 ±0.05				1.0 max
NRCS10	0805		1.65 ±0.20	2.40 ±0.20				1.0 max					
NRCS12	1206		2.00 ±0.20	3.50 ±0.20				1.0 max					
NRCS25	1210		2.85 ±0.20	3.50 ±0.20				1.0 max					
NRCS50	2010	Embossed Plastic	2.90 ±0.20	5.40 ±0.20	12.0 ±0.20	5.50 ±0.05						1.10 max.	0.25 max
NRCS100	2512		3.40 ±0.20	6.60 ±0.20									

PAPER CARRIER

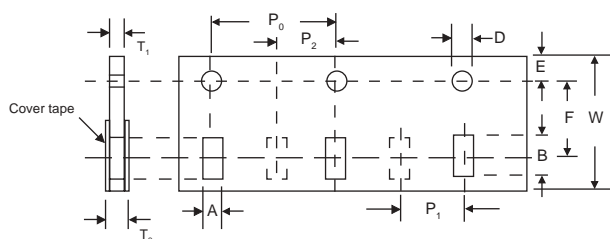

EMBOSSED PLASTIC CARRIER

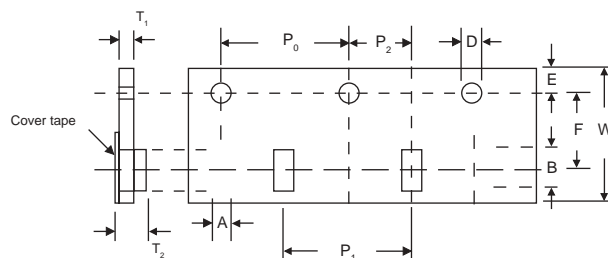

REEL DIMENSIONS (mm)

Type	EIA Case Size	A	B	C	D	E	W	Qty
NRCS04	0402	180 <small>+0.0 -3.0</small>	60 <small>+1.0 -3.0</small>	13.0 <small>±0.20</small>	21.0 <small>±0.80</small>	2.0 <small>±0.50</small>	9.00 <small>±0.30</small>	10,000
NRCS06	0603							5,000
NRCS10	0805							
NRCS12	1206							
NRCS25	1210							
NRCS50	2010						13.0 <small>±0.30</small>	4,000
NRCS100	2512							

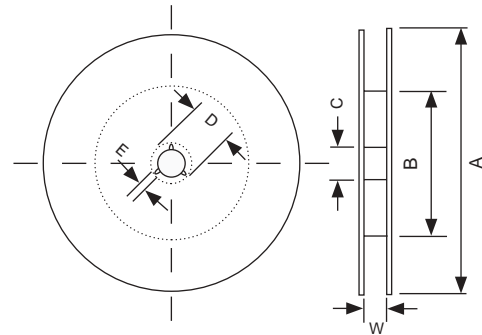

LAND PATTERN DIMENSIONS (mm)

Type	EIA Case Size	A	B	C
NRCS04	0402	0.5	1.3	0.5
NRCS06	0603	0.9	2.6	0.7
NRCS10	0805	1.35	3.45	1.1
NRCS12	1206	2.2	4.7	1.4
NRCS25	1210	2.2	5.2	2.15
NRCS50	2010	3.7	6.2	2.15
NRCS100	2512	4.7	7.6	2.75

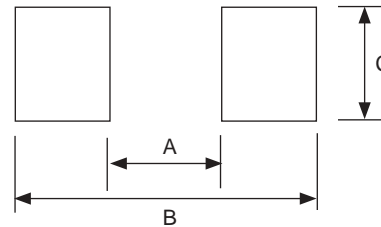

REFLOW SOLDERING TEMPERATURE PROFILE

