

RB2 Series

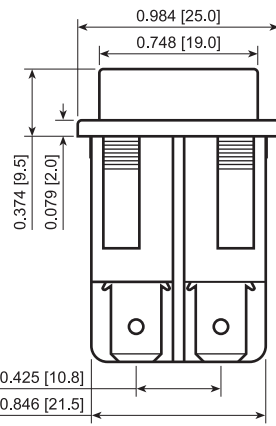

Terminal Options

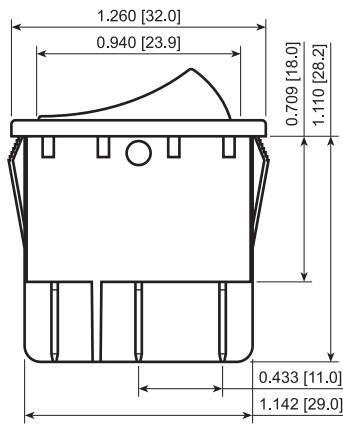
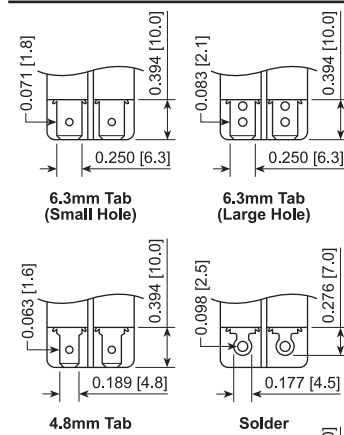

FEATURES:

- High Quality and Reliable Switch
- Industry Standard 22mm x 30mm Cutout
- Illuminated and Signal Light Versions
- Multiple Terminal and Actuator Options
- PVC Cap for Dust and Water Protection

SPECIFICATIONS:

RATING: RATING OPTION C:
16A 125VAC T85 [cULus]
8A 250VAC T85 [cULus]
16(4)A 250V~ 1E4 T125/55 [ENEC]

RATING OPTION D (2 Pos. FUNCTIONS):
20A 125VAC T65 [cULus]
1/4HP 125VAC T65 [cULus]
3/4HP 250VAC T65 [cULus]
16(8)A 250V~ 1E4 T125 [ENEC]
10(2)A 250V~ 5E4 [ENEC]
16(4)A 250V~ 1E4 T85/55 [ENEC]

RATING OPTION E (3 Pos. FUNCTIONS):
16A 125VAC T65 [cULus]
16A 250VAC T65 [cULus]
European Rating Pending

TEMPERATURE: -20°C to 65°C Min.
ELECTRICAL LIFE: 10,000 Cycles
CONTACT RESISTANCE: 35mΩ Max. at 50VAC
INSULATION RESISTANCE: 100MΩ Min. at 500VAC
DIELECTRIC STRENGTH: 1,500VAC for 1 Minute
INGRESS PROTECTION: IP54 with PVC Cap

MATERIALS:

BODY: Polyamide 6/6, UL94 V-2
ACTUATOR: Polyamide 6/6, UL94 V-2
Polycarbonate, UL94 V-2
CONTACTS: Silver Plated Copper

Panel Cutout

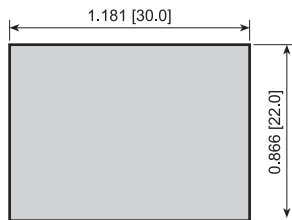

Water Protection Options

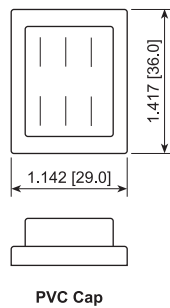

Actuator Options

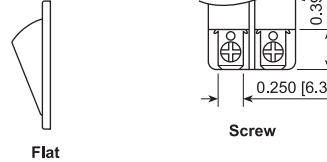

Illumination Options

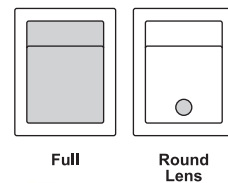

SPECIFICATIONS SUBJECT TO CHANGE WITHOUT NOTICE



RB242D1000-136 / ACC-F02-1

RB246E1100 / ACC-F04-1

Series	Terminal	Function	Rating	Body Color	Actuator Color	Marking Color	Marking Type	Lens Style	Lens Color	Lamp Voltage
RB2 - Curved	1 - 4.8mm Tab	1 Pole:	C - 16A 125V	1 - Black	0 - Full Illum.	0 - None	0 - None	1 - Full	0 - Clear	3 - 6V
RB2F - Flat	4 - 6.3mm Tab (Small Hole)	1 - Off-On	D - 20A 125V	2 - White	1 - Black	1 - Black	1 - I/O Vert.	2 - Round (*)	1 - Red	4 - 12V
	5 - Solder	3 - On-On	E - 16A 125V	3 - Almond	2 - White	2 - White	2 - ON/OFF/ON Vert.		2 - Amber	5 - 24V
	6 - Screw	5 - On-Off-On		4 - Grey	3 - Almond	3 - Almond	3 - ON/OFF Vert.		3 - Green	6 - 125V
	B - 6.3mm Tab (Large Hole)	C - On-Off-(On)		9 - Red	4 - Grey	4 - Grey	4 - ON/OFF Horiz.		4 - Blue	7 - 250V
		D - (On)-Off-(On)			5 - Orange	5 - Orange	5 - I/O/II Horiz.			
		2 Pole:			7 - Blue	7 - Blue	S - I/O/II Vert.			
		2 - Off-On			8 - Green	8 - Green	R - I/O Horiz.			
		G - On-On			9 - Red	9 - Red				
		E - Off-(On)								
		H - On-(On)								
		6 - On-Off-On								
		J - On-Off-(On)								
		K - (On)-Off-(On)								

Note: * = Option Available with "C" Rating Only

Custom Colors and Markings Available Upon Request For Illuminated Switches Only

EXAMPLE PART NUMBERS:

- RB242D1100 2P Off-On
Black Body/Actuator, No Marking
- RB242D1121 2P Off-On
Black Body/Actuator, I/O Vert.
- RB242D1921 2P Off-On
Black Body, Red Actuator, I/O Vert.
- RB24KE1100 2P (On)-Off-(On)
Black Body/Actuator, No Marking

