

EMI Filters



Introduction to Knowles Capacitors

Knowles Capacitors is a global company dedicated to the manufacture of ceramic based electronic components. Knowles has been producing Multilayer Ceramic Capacitors for over 25 years and its employees are committed to providing customers with high quality products together with a fast, friendly and flexible service from a state-of-the-art facility.

Production process

At the core of Knowles' ceramic manufacturing technology is the 'Wet Process'. This fully integrated computer-controlled manufacturing operation is in a clean room environment, and offers unique advantages in the manufacture of filter products. This has resulted in Knowles being a world leader in the manufacture of EMI filters, discoidal capacitors and planar arrays. Our multilayer ceramic manufacturing and filter assembly facility holds a number of internationally recognised approvals including ISO 9001. Specific product approvals/qualifications include IECQ CECC, UL, TÜV and AEC-Q200.

Products

Knowles' excellence in ceramic materials technology, combined with EMI filter expertise, has enabled us to offer an unrivalled range of EMI filter products including:

- Surface Mount Filters including:
 - Feedthrough Chip Capacitors
 - Surface Mount C Filters
 - Surface Mount Pi Filters
 - X2Y - Integrated Passive Components



- Solder-in Panel Mount Filters
- Resin Sealed Ceramic Threaded Panel Mount Filters
- Discoidal Capacitors
- Planar Capacitor Arrays

Benefits

Surface Mount EMI Filters

- High capacitance, high voltage, high current Pi filters
- FlexiCap™ termination an option
- AEC-Q200 approvals

Panel Mount EMI Filters

- Use of Stable X7R and C0G/NP0 ceramics - no Z5U/Y5V
- High capacitance values, high voltage
- High frequency performance to greater than 10GHz

X2Y

- Available with FlexiCap™ termination
- AEC-Q200 and medical implantable
- Available in surface mount, panel mount and planar array versions

Discoidal Capacitors

- Small sizes, high capacitance values, high voltage capability
- Custom sizes available

Planar Arrays

- Mechanical superiority, tighter mechanical tolerances
- High voltage capability, mixed capacitance values
- Available in capacitor and X2Y formats

Multilayer Filter Assemblies

- Can use either discoidal capacitor elements or planar arrays
- Full custom design facility

Other Knowles products

- Multilayer ceramic chip capacitors
- High Voltage MLCCs
- FlexiCap™ Capacitors with flexible terminations
- StackiCap™ High CV Capacitors
- Class 'X' and 'Y' SMD Safety Certified Capacitors
- Radial Leaded Capacitors
- AEC-Q200 approved Capacitors
- IECQ CECC approved Capacitors
- Capacitors for space applications
- High Q Ultra-low ESR Capacitors
- Non-magnetic Capacitors
- High Power Ribbon Leaded
- High Temperature Capacitors



DLI•JohansonMFG•Novacap•Syfer•Voltronics



www.knowlesc capacitors.com

Contents

General and Technical Introduction	EMI Filters Quick Reference Guide	2-3
	The need for EMI Filters	4
	Explanation of common terms	5
	Insertion Loss/Filtering performance	6
	Choice of ceramic dielectric material	7
	Panel mount EMI Filters - Application considerations	8
	MIL-STD-461 and EMI Filters - Common misconceptions	9
Installation of Filters	10-11	
<hr/>		
SM EMI Filters	Introduction.....	12
	Insertion Loss	13-14
	3-terminal Feedthrough Capacitors (E01 & E07)	15-16
	C and Pi Filter ranges	17-21
	X2Y - Integrated Passive Components (E03)	22-23
	Packaging information	24-25
<hr/>		
Panel Mount EMI Filters	Introduction to Panel Mount EMI Filters	26
	Insertion Loss	27
	Solder-in Panel Mount EMI filters.....	28-31
	Resin Sealed Ceramic Threaded Panel Mount EMI Filters	32-76
<hr/>		
Discoidals, Planar Arrays and Special Filters	Discoidal and Planar Arrays	77-79
	Special Filters and Assemblies	80
	Filters for Hi-Rel applications.....	81
	Additional Resources	82
	Product Safety Information	83

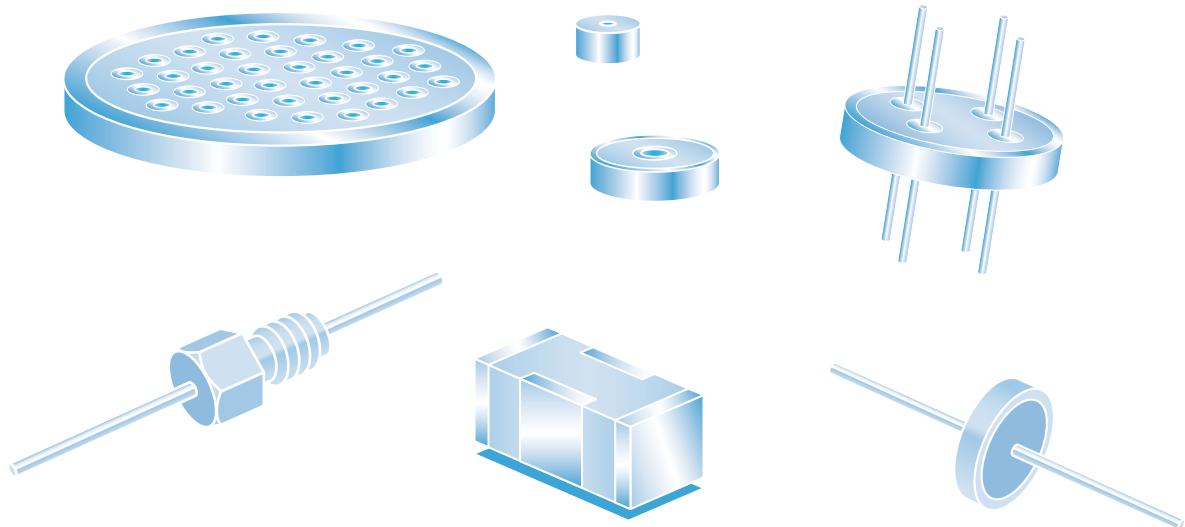

Quick Reference Guide

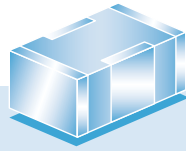

Surface Mount

Range	Mounting	Description	Circuit Type	Capacitance Range	Page
E01	Surface Mount	300mA EMI chip. Sizes 0805, 1206 & 1806	C	10pF - 200nF	15/16
E07	Surface Mount	1A to 3A rated EMI chip. Sizes 0805, 1206, 1806 & 1812	C	10pF - 1.8µF	15/16
SBSPP	Surface Mount	1A rated Pi filter. Size 1206	Pi	22pF - 150nF	17
SBSGC	Surface Mount	10A rated C filter. Size 1812	C	1.0nF - 220nF	18
SBSGP	Surface Mount	5A rated Pi filter. Size 1812	Pi	1.0nF - 220nF	19
SBSMC	Surface Mount	20A rated C filter. Size 2220	C	1.0nF - 470nF	20
SBSMP	Surface Mount	10A rated Pi filter. Size 2220	Pi	1.0nF - 470nF	21
E03	Surface Mount	Balanced Line chips (X2Y)	C	10pF - 1.2µF	22/23

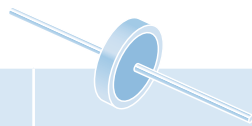

Solder-in Panel Mount

Range	Mounting	Description	Circuit Type	Capacitance Range	Page
SFSSC	Solder	Discoidal F/T capacitor with leads. 2.3 to 8.75mm body diameter	C	10pF - 3.3µF	28
SFSRC	Solder	Resin Sealed 2.8mm body diameter	C	10pF - 47nF	29
SFSTC	Solder	Resin Sealed 3.25mm body diameter	C	10pF - 100nF	30
SFSUC	Solder	Resin Sealed 5.6mm body diameter	C	10pF - 680nF	31

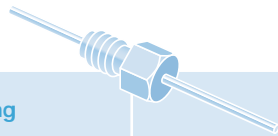

Resin Sealed Ceramic Threaded

Range	Mounting	Description	Circuit Type	Capacitance Range	Page
SFAAC	4-40 UNC Class 2A thread	4.0mm hexagonal head	C	10pF - 150nF	32
SFABC	6-32 UNC Class 2A thread	4.0mm hexagonal head	C	10pF - 150nF	33
SFABL	6-32 UNC Class 2A thread	4.0mm hexagonal head	L-C	10pF - 150nF	34
SFAJC	M3 x 0.5 - 6g thread	4.0mm hexagonal head	C	10pF - 150nF	35
SFAJL	M3 x 0.5 - 6g thread	4.0mm hexagonal head	L-C	10pF - 150nF	36
SFAKC	M3.5 x 0.6 - 6g thread	4.0mm hexagonal head	C	10pF - 150nF	37
SFAKL	M3.5 x 0.6 - 6g thread	4.0mm hexagonal head	L-C	10pF - 150nF	38
SFAKT	M3.5 x 0.6 - 6g thread	4.0mm hexagonal head	T	10pF - 150nF	39
SFBCC	8-32 UNC Class 2A thread	4.75mm hexagonal head	C	10pF - 150nF	40
SFBCL	8-32 UNC Class 2A thread	4.75mm hexagonal head	L-C	10pF - 150nF	41
SFBCE	8-32 UNC Class 2A thread	4.75mm hexagonal head	Pi	20pF - 94nF	42
SFBDC	12-32 UNEF Class 2A thread	4.75mm hexagonal head / 6.35mm flange	C	10pF - 150nF	43
SFBDL	12-32 UNEF Class 2A thread	4.75mm hexagonal head / 6.35mm flange	L-C	10pF - 150nF	44
SFBDE	12-32 UNEF Class 2A thread	4.75mm hexagonal head / 6.35mm flange	Pi	20pF - 300nF	45
SFBDF	12-32 UNEF Class 2A thread	4.75mm hexagonal head / 6.35mm flange	T	10pF - 150nF	46
SFBLC	M4 x 0.7 - 6g thread	4.75mm hexagonal head	C	10pF - 150nF	47
SFBLL	M4 x 0.7 - 6g thread	4.75mm hexagonal head	L-C	10pF - 150nF	48
SFBLE	M4 x 0.7 - 6g thread	4.75mm hexagonal head	Pi	20pF - 94nF	49
SFBMC	M5 x 0.8 - 6g thread	4.75mm hexagonal head / 6.35mm flange	C	10pF - 150nF	50
SFBML	M5 x 0.8 - 6g thread	4.75mm hexagonal head / 6.35mm flange	L-C	10pF - 150nF	51

Quick Reference Guide



Resin Sealed Ceramic Threaded

Range	Mounting	Description	Circuit Type	Capacitance Range	Page
SFBMP	M5 x 0.8 - 6g thread	4.75mm hexagonal head / 6.35mm flange	Pi	20pF - 300nF	52
SFBMT	M5 x 0.8 - 6g thread	4.75mm hexagonal head / 6.35mm flange	T	10pF - 150nF	53
SFCDC	12-32 UNEF Class 2A thread	6.35mm hexagonal head	C	10pF - 680nF	54
SFCDL	12-32 UNEF Class 2A thread	6.35mm hexagonal head	L-C	10pF - 680nF	55
SFCDP	12-32 UNEF Class 2A thread	6.35mm hexagonal head	Pi	20pF - 300nF	56
SFCMC	M5 x 0.8 - 6g thread	6.35mm hexagonal head	C	10pF - 680nF	57
SFCML	M5 x 0.8 - 6g thread	6.35mm hexagonal head	L-C	10pF - 680nF	58
SFDPP	M8 x 0.75 - 6g thread	10mm hexagonal head	Pi	9.4nF - 940nF	59
SFJGC	¼-28 UNF Class 2A thread	9.8mm round head	C	100pF - 3.3µF	60
SFJGL	¼-28 UNF Class 2A thread	9.8mm round head	L-C	100pF - 3.3µF	61
SFJGP	¼-28 UNF Class 2A thread	9.8mm round head	Pi	660pF - 6.6µF	62
SFJNC	M6 x 0.75 - 6g thread	9.8mm round head	C	100pF - 3.3µF	63
SFJNL	M6 x 0.75 - 6g thread	9.8mm round head	L-C	100pF - 3.3µF	64
SFKBC	6-32 UNC Class 2A thread	4.4mm round head	C	10pF - 150nF	65
SFKBL	6-32 UNC Class 2A thread	4.4mm round head	L-C	10pF - 150nF	66
SFKKC	M3.5 x 0.6 - 6g thread	4.4mm round head	C	10pF - 150nF	67
SFKKL	M3.5 x 0.6 - 6g thread	4.4mm round head	L-C	10pF - 150nF	68
SFKKT	M3.5 x 0.6 - 6g thread	4.4mm round head	T	10pF - 150nF	69
SFLMC	M5 x 0.8 - 6g thread	6.0mm round head	C	10pF - 150nF	70
SFLML	M5 x 0.8 - 6g thread	6.0mm round head	L-C	10pF - 150nF	71
SFLMP	M5 x 0.8 - 6g thread	6.0mm round head	Pi	20pF - 300nF	72
SFLMT	M5 x 0.8 - 6g thread	6.0mm round head	T	10pF - 150nF	73
SFTMC	M5 x 0.8 - 6g thread	6.35mm hexagonal head	C	10pF - 150nF	74
SFUMC	M5 x 0.8 - 6g thread	6.0mm round head	C	10pF - 150nF	75
SFJEB	¼-28 UNF Class 2A thread	Balanced Line EMI Filter	X2Y	4.7nF - 100nF	76



Discoidal and Planar Arrays

For Discoidal and Planar Arrays see pages 77 to 78.

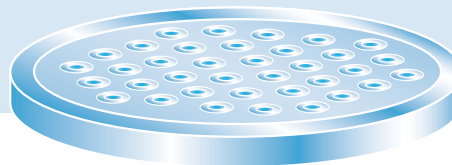

The need for EMI Filters

The use of electronic equipment is ever-increasing, with greater likelihood of interference from other pieces of equipment. Added to this, circuits with lower power levels that are more easily disturbed means that equipment is increasingly in need of protection from EMI (electromagnetic interference). To meet legislation such as the EU Directive on EMC, in addition to other international regulations such as FCC, EMI filtering is now an essential element of equipment design. Introducing screening measures, eg to the case or cables, may suffice in many instances, but some form of low-pass filtering will often be required.

Faraday Cage

The ideal way of protecting a piece of equipment or circuit from EMI is to totally enclose it in a metal (or conductive) box. This screened enclosure is called a 'Faraday Cage'. Radiated interference is thus prevented from adversely affecting it (Fig 1).

Input/output cabling

In reality however, most pieces of equipment require input and/or output connections, perhaps power cables or signal and control lines. The cables providing these connections can act as antennae, able to pick up interference and also to radiate it (Fig 2). Any cable or wire going in through the equipment case can introduce electrical noise, and also radiate it internally onto other wires and circuits. Similarly, it can provide a path to the outside from any noise generated internally, which can also then be radiated and may in turn adversely affect other equipment.

1. Interference can enter a piece of equipment directly through the cabling (conducted interference).
2. Radiated interference can travel directly to the affected equipment.
3. Interference can exit an EMI source via a cable, subsequently to be radiated from the cable and to the affected equipment.
4. Interference can be radiated from an EMI source and then picked up by a cable entering the affected equipment.

Filter location - Panel Mount filters

To prevent interference entering or leaving a piece of equipment, feedthrough EMI filters can be mounted in the wall of a shielded case. Any incoming or outgoing cables would then pass through the filters. Power or wanted signals pass through the filters unaffected, whilst higher frequency interference is removed. While the screened case protects against radiated interference, the feedthrough filters protect against conducted interference. The integrity of the equipment is thus assured (Fig 3).

Filter location - Surface Mount filters

Where there is no suitable bulkhead for mounting the filters, pcb types can be used (Fig 4). While this can be an effective method of filtering, it should be noted that in general the insertion loss performance can be reduced at higher frequencies, unless additional screening measures are taken.

Good design practices such as short tracks, short connections, close proximity to input and good grounding will help improve insertion loss performance.

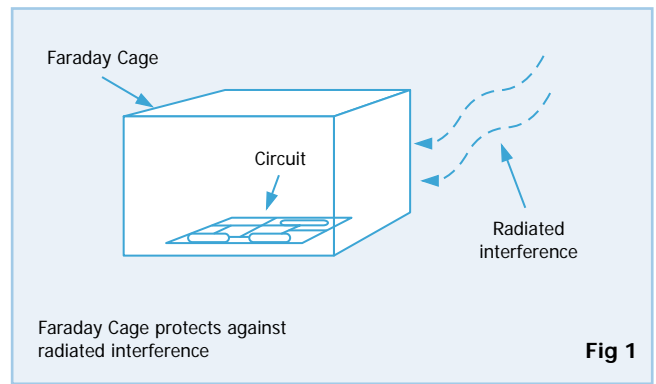

Fig 1

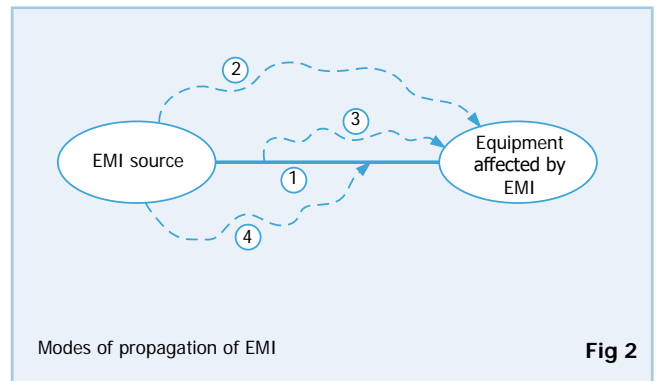

Fig 2

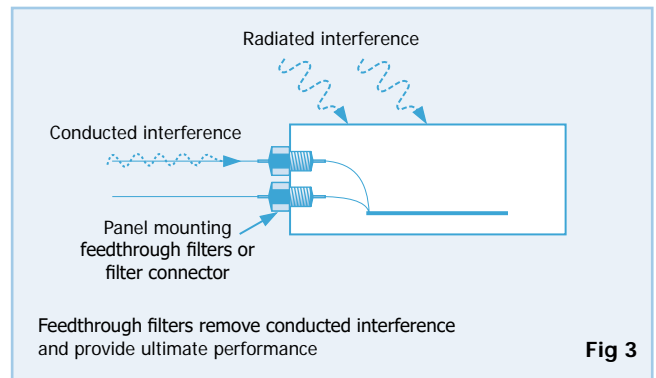

Fig 3

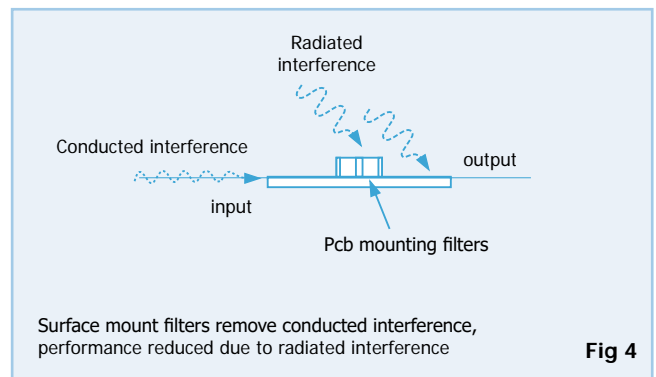

Fig 4

Explanation of common terms

Conducted Interference

Interference transmitted along a conductor/cable.

Protection is provided by a series component. If a feedthrough filter is used to remove conducted interference, and mounted in the wall of a shielded compartment, it provides effective filtering while maintaining the screening integrity. It should be noted that the filter will reduce both emissions and susceptibility.

Cut-off Frequency/3dB point

The frequency at which filters start to become effective.

Generally taken to be at the 3dB point of the attenuation curve. Anything on the line below this frequency will be unaffected. The higher the capacitance of the filter the lower the cut-off, and vice versa. It will also vary depending on source and load impedances.

EMC

ElectroMagnetic compatibility.

A situation wherein two pieces of electrical or electronic equipment are able to function in the same environment without adversely affecting, or being affected by, each other.

EMI

ElectroMagnetic interference.

A broad term covering a wide range of electrical disturbances, natural and man-made, from dc to GHz frequencies and beyond. Sources of disturbance may include radar transmitters, motors, computer clocks, lightning, electrostatic discharge and many other phenomena.

Conducted Emissions

Signals, unwanted (interference) or otherwise from a piece of equipment.

Radiated Interference

Interference transmitted in free air.

Protection is provided by shielding, but if filters are not used to protect against conducted emissions, the unfiltered lines can act as aerials radiating interference outside the shielded cage.

Susceptibility

The extent to which a piece of equipment is vulnerable to interference emitted from another piece of equipment.

ESD

Electrostatic discharge.

ESD can result in damage through excessive voltage spikes. We can offer assistance on whether our products can meet specific ESD test requirements.

Insertion Loss

At a given frequency, the insertion loss of a feedthrough suppression capacitor or filter connected into a given transmission system.

Defined as the ratio of voltages appearing across the line immediately beyond the point of insertion, before and after insertion. As measured herein, insertion loss is represented as the ratio of input voltage required to obtain constant output voltage, with and without the component, in the specified 50Ω system. This ratio is expressed in decibels (dB) as follows:

$$\text{Insertion loss} = 20 \log \frac{E_1}{E_2}$$

Where: E_1 = The output voltage of the signal generator with the component in the circuit.

E_2 = The output voltage of the signal generator with the component not in the circuit.

When testing is conducted with a network/spectrum analyser, the equipment usually maintains a constant output voltage and can be set to record the output to input voltage ratio in decibels.

Low-pass Filter

A filter that lets through dc and low frequency signals, while attenuating (unwanted) high frequency noise.

Panel Mount Filter

A panel mounted filter that will pass the signal from one side of the wall of a shielded box (or 'Faraday Cage') to the other (it feeds the signal through the panel).

For effective operation, the filter input and output should be screened from each other, ie there should ideally be no apertures in the panel.

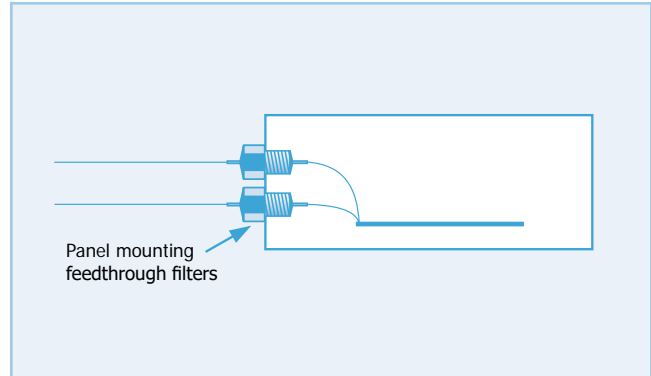

Surface Mount Filter

A filter that is suitable for surface mounting on PCBs.

It offers improved filtering compared to standard MLCCs, ease of assembly and savings on board space compared to a combination of discrete filter elements. Filter performance at higher frequencies is reduced compared to panel mount types, unless additional shielding measures are taken (see page 10).

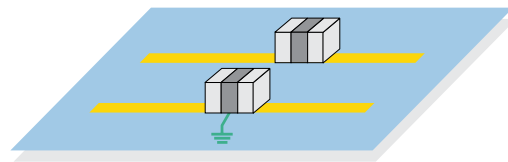

Working Voltage

Continuous operating voltage.

This can potentially be across the entire operating temperature range.

X2Y Filter

Integrated passive component with extremely low self inductance for filtering and de-coupling.

For filtering applications:

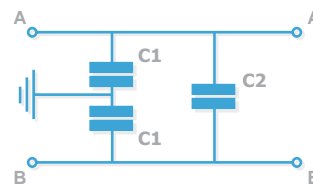

For de-coupling applications:

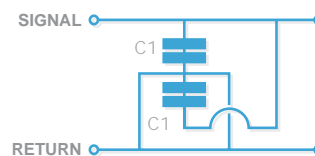

Insertion Loss/Filtering performance

The insertion loss performance is used to aid filter selection by showing signal attenuation at any given frequency. However, it can only ever be a guide as actual performance in service will vary depending on the overall circuit characteristics.

Insertion loss is determined by:

- Electrical configuration
- Source/load impedances
- The load current (which can cause ferrite saturation)
- Ceramic dielectric materials. The capacitance change will be affected by applied voltage, temperature and the age of the part
- Earthing impedance
- Shielding integrity

Electrical Configuration

A number of different electrical configurations are available in feedthrough filters, including the common types shown opposite. A single element filter (a capacitor or an inductor) theoretically provides an insertion loss characteristic of 20dB per decade, a dual element filter (capacitor/inductor) 40dB per decade whilst a triple element filter (Pi or T configuration) theoretically yields 60dB per decade. In practise, the insertion loss curves do not exactly match the predictions, and the data sheets should be consulted for the realistic figure. The choice of electrical configuration is made primarily on the source and load impedances and may also be influenced by the level of attenuation required at various frequencies.

C Filter

This is a feedthrough capacitor with low self inductance. It shunts high frequency noise to ground and is suitable for use with a high impedance source and load.

L-C Filter

This is a feedthrough filter with an inductive element in combination with a capacitor. It is commonly used in a circuit with a low impedance source and a high impedance load (or vice versa). The inductive element should face the low impedance.

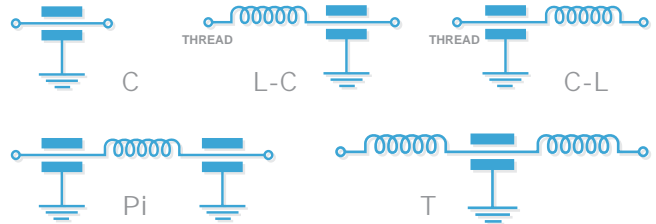

Pi Filter

This is a feedthrough filter with 2 capacitors and an inductive element between them. Ideally, it should be used where both source and load impedances are high.

T Filter

This is a feedthrough filter with 2 series inductive elements separated by one feedthrough capacitor. It is suitable for use where both source and load impedances are low.

Multi-element filters

These filters contain more than 3 elements, for example L-C-L-C-L filters. The addition of further elements increases the steepness of the insertion loss curve.

Source and Load Impedances

Insertion loss figures are normally published for a 50Ω source and 50Ω load circuit. In practise the impedance values will probably be very different, which could result in either an increase or decrease in insertion loss. The electrical configuration of the filter (the capacitor/inductor combination) should be chosen to optimise

the filter performance for that particular source/load impedance situation. An estimate of insertion loss for source and load impedances other than 50Ω may be possible. Please contact our Sales Office.

Load Current

For filters which include ferrite inductors, the insertion loss under load current may be less than that with no load. This is because the ferrite material saturates with current. The reduction in insertion loss depends on the current and the characteristics of the

particular ferrite material. In extreme cases the ferrite will become ineffective and insertion loss will appear to be the same as for a C filter. For further information contact the Sales Office.

Attenuation Curve

A plot of insertion loss versus frequency on a logarithmic scale.

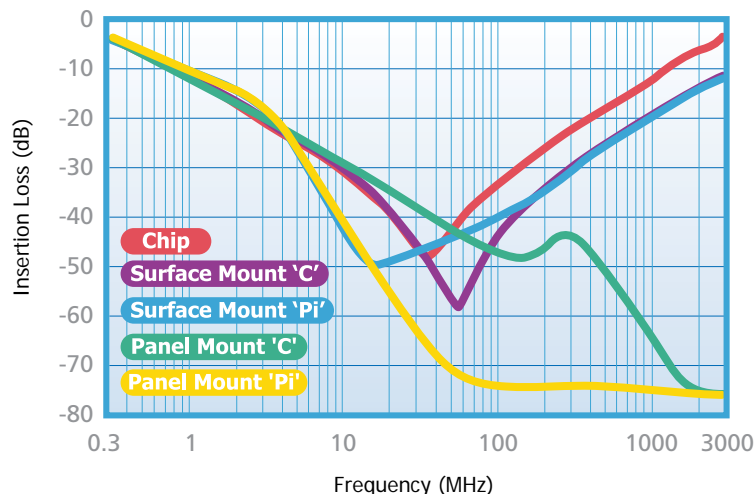

Choice of ceramic dielectric material

When choosing a filter, it is important to be aware of the different performance characteristics that may be available from different categories of ceramic materials employed in their capacitors. Generally, stability of dielectric constant (and therefore filter capacitance value), with respect to some operational and environmental parameters, deteriorates with increasing dielectric constant. Specific factors which affect dielectric constant are temperature, voltage, frequency and time (ageing).

The three main classifications of ceramic dielectric employed in the manufacture of EMI filters are generally referred to as ultra stable (COG/NP0), stable (X7R) and general purpose (Z5U, Y5V or X7W).

COG/NP0

Most parameters for materials in this dielectric classification remain unaffected by temperature, voltage, frequency or time. Stabilities are measured in terms of parts per million but dielectric constants are relatively low (10 to 100).

X7R

This is a classification for materials which are relatively stable with respect to temperature, voltage, frequency and time. Typical dielectric constants would be of the order 2,000 to 4,000, enabling the achievement of far higher capacitance values for a given size of capacitor than can be gained from COG/NP0 materials.

If the voltage coefficient (VC) is critical, Syfer are also able to offer parts with BX (2X1) and BZ (2C1) VC characteristics. Refer to the factory for further details.

Z5U/Y5V/X7W

These are classifications for materials which are severely restricted and performance under applied voltage may be seriously compromised.

A summary of the specifications of these materials follows. Please note that Syfer uses only the higher performance COG/NP0 and X7R in its standard ranges.

Summary of ceramic dielectric characteristics

	COG/NP0	X7R	Z5U	Y5V	X7W
EIA dielectric classification	Ultra stable	Stable	General purpose		
Rated temperature range	-55°C to +125°C	-55°C to +125°C	-10°C to +85°C	-30°C to +85°C	-55°C to +125°C
Maximum capacitance change over temperature range (no voltage applied)	0 ±30 ppm/°C	±15%	+22-56%	+22-56%	+40-90%
Ageing characteristics	Zero	<2% per time decade	6% per time decade	6% per time decade	6% per time decade

Spread of capacitance values

The capacitance of a ceramic capacitor can change as a result of a change in temperature, applied voltage and age. Please note that this potential change can lead to a significant drop in filtering performance.

Consider the typical performance of 5,000pF filter capacitors, offered in standard dielectric classifications, operating at a voltage of 100Vdc at 85°C, at an age of 10,000 hours. The final capacitance

value can fall within the range of values (see chart below), taking into account the ageing process and effects of temperature and voltage as shown in the chart above.

It is clear that the capacitance can change as a result of an increase (or decrease) in temperature, applied voltage and as a result of ageing. If the capacitance has reduced, so too will the insertion loss performance.

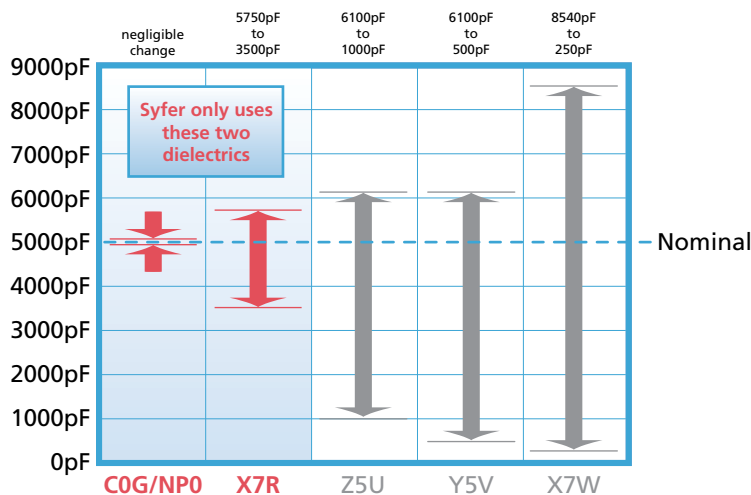

Panel Mount EMI Filters - Application considerations

Thread size or head size? What's the crucial factor in spacing

The thread size has no relevance to the mounting pitch, but can influence cost. Very small threads are harder to work with, but offer little or no gain over larger thread sizes.

If close mounting pitch is important, change instead to a round body style. Mounted using modified screwdriver blades, this style of component removes the need to allow space for mounting sockets and allow components to be mounted almost touching each other.

Syfer offer a full range of round head filter types - SFKB, SFKK, SFLM and SFUM. Special requirements can also be considered.

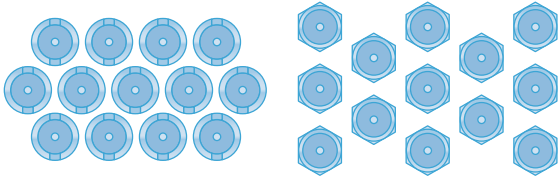

Schematic showing the pitch improvement that can be gained with round head filters compared to traditional hexagon heads.

Hermetic seals vs resin seals

Resin sealed filters have epoxy encapsulants injected into the cavities either side of the filter elements. The purpose of the resin is to 'ruggedise' the assembly, supporting the pins and sealing the ceramic to prevent reliability issues such as moisture ingress. Poor encapsulants can be susceptible to cracking away from the metalwork due to temperature change. This can then allow moisture ingress which can result in reliability concerns. They can also exert a force on the ceramic which can result in cracking causing electrical failure. MIL or Space specifications generally do not demand resin sealed filters be tested for immersion or accelerated damp heat testing.

Syfer resin sealed filters use a very high purity, highly filled, epoxy encapsulant with a very low co-efficient of thermal expansion – very closely matched to the expansion co-efficient of the ceramic and other materials used in the construction. These characteristics enable Syfer filters to be thermally cycled with very little stress being applied to the ceramic elements and with reduced risk of cracking allowing moisture ingress. Certain Syfer filters have successfully passed immersion and accelerated damp heat testing.

Screw mount 'hermetic' filters generally have glass to metal seals soldered into place instead of conventional resin seals. They are better than resin sealed filters in applications where outgassing is critical, or where the environment is particularly harsh. MIL or Space specifications generally do require hermetically sealed filters be tested for immersion or accelerated damp heat testing. Unless fitted with sealing rings, they will not normally provide a gas seal between either side of the mounting bulkhead – the seal is to protect the internal capacitor elements. Solder mount hermetic filters may create a gas seal between either side of the bulkhead, but this is more dependent on the sealing capabilities of the solder joint mounting the filter rather than the filter seal. Usually, solder mount filters only have a glass seal on one side of the filter body, with the other end resin sealed. Test plans are normally the same as those for resin sealed filters. Hermetically sealed solder mount filters are only normally required in applications where one end of the filter will be exposed to harsh environments, or where outgassing is critical on one side of the panel.

Please note: Knowles do not currently offer hermetic EMI filters.

Discoidal capacitor vs tubular capacitor

The original panel mount filters used single layer tubular capacitors. There is one major advantage of this type of capacitor - it lends itself to very easy Pi filter construction. For this reason, Pi filters have tended to be considered the optimum filter configuration.

As performance demands increased, higher capacitance values were required. High K, unstable (Z5U / Y5V see page 7) dielectrics and multilayer tubes began to be used. These use buried layer electrodes within the tube walls, but the reduced dielectric thickness resulted in lower voltage withstand capability. The unstable dielectrics result in poor performance over the voltage and temperature ranges.

Tubular capacitors have one major flaw - the thin ceramic walls make them very prone to cracking causing electrical failures.

As MLCC chip capabilities developed, the discoidal capacitor appeared in filters. These devices use MLCC chip technology to produce a very low inductance (low ESL / low ESR) capacitor giving improved performance and higher capacitance and voltage ranges (higher capacitance per unit voltage). They are physically much stronger and robust than tubes.

Most Syfer panel mount filters use discoidal capacitors for optimum mechanical strength and high quality X7R or COG/NPO dielectric materials for optimum electrical performance. However, there are other dielectric materials used in the manufacture of filters.

	Advantages	Disadvantages
Tube based filters	Cheap. Suited to Pi filter manufacture.	Low capacitance only, not robust – easily cracked multilayer tubes = higher capacitance but low voltage.
Disc based filters	Robust. High capacitance. C, L-C, & T circuits easy. Very high capacitance Pi filters possible. Tight tolerance possible. Vc characteristics possible.	Low capacitance Pi filters, relatively expensive.

Tubular capacitor

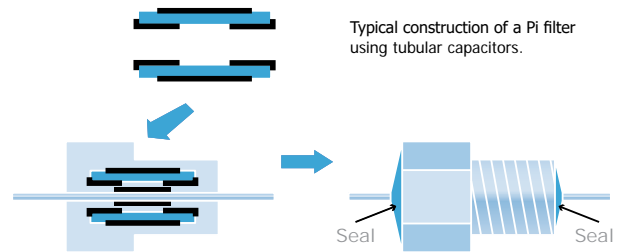

Multilayer discoidal capacitor

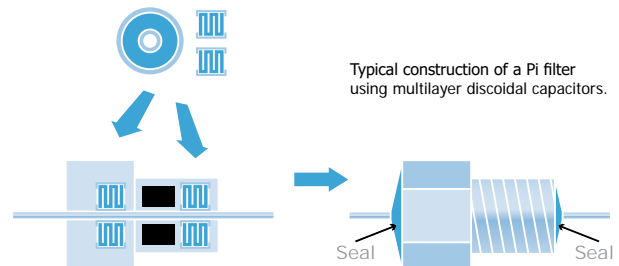

MIL-STD-461 & EMI Filters - Common misconceptions

We routinely get filter enquiries that are typically quoting "filters must meet the requirements MIL-STD-461" or "filters must comply with MIL-STD-461". This is a complete mis-understanding of MIL-STD-461 and needs to be clarified with the customer.

The following might be useful.

The US MIL-STD-461 specification sets regulations for the control of electromagnetic interference emissions and susceptibility of equipment. It sets requirements for the levels of emissions allowed to be exported from electrical equipment and it also sets requirements as to the susceptibility levels of equipment from external noise sources. In addition it gives guidelines on measuring those features of the equipment.

A piece of electrical equipment behaves as a "source" and will generate EMI. That EMI will be transmitted by conduction and radiation, and be incident upon a receiver (which may be another piece of electrical equipment or a test fixture). The level of the electromagnetic signature of the conducted emissions is determined by the characteristics of the equipment; e.g. SMPS's may be "noisy", filament lights may be "quiet".

If the levels of emissions from the equipment exceed the limits set in MIL-STD-461, then they need to be attenuated by using an EMI filter. The performance of that filter across the frequency spectrum must be to allow the equipment emissions to be suppressed to a level low enough to allow the equipment to claim compliance with the limits of the specification. That filter performance requirement is determined by the electromagnetic signature of the equipment, and what limits are required to be achieved. The filter manufacturer of course can only get this information from the manufacturer of the equipment. Then the claim for compliance can normally be verified by test and measurement.

This explains why no filter manufacturer can claim that their filters "meet" MIL-STD-461; it is not the filter which "meets" the specification, but the equipment or platform. The situation might be that a filter proposed is "above specification" requirement, and the equipment conforms to MIL-STD-461 very comfortably. On the other hand, equipment in the system may be so electromagnetically noisy that a proposed filter fails to support the equipment in meeting the limits of MIL-STD-461.

Syfer are not able to guarantee that the incorporation of a particular filter into the Client's equipment will enable system compliance

with the emissions limits of specification MIL-STD-461. All filter manufacturers catalogue their filter performance as insertion loss in a reference (normally 50Ω) impedance system. The filter manufacturer does not know the level of emissions associated with a piece of equipment, nor the real-world terminating impedances as presented to the filter. Hence the published filter insertion loss performance at/across a particular frequency range will not necessarily represent the equivalent attenuation of equipment emissions in application and the equipment manufacturer will need to conduct their own tests to determine the part is suitable and the filtered equipment meets the requirements of MIL-STD-461.

In summary MIL-STD-461 is an equipment specification and cannot be applied to filters. We understand some filter manufacturers may be quoting MIL-STD-461 in their literature, but this is either lack of understanding of the specification, or 'salesmanship'. It is the responsibility of the equipment manufacturer to meet MIL-STD-461, and no filter supplier can ever properly quote it.

If we have a filter enquiry where the customer refers to MIL-STD-461, we need to ask exactly what level of attenuation they require. We can then suggest part numbers based on that detail, but ultimately they will need to test parts to determine if they are suitable. Professional EMC test houses may be able to help suggesting requirements as well.

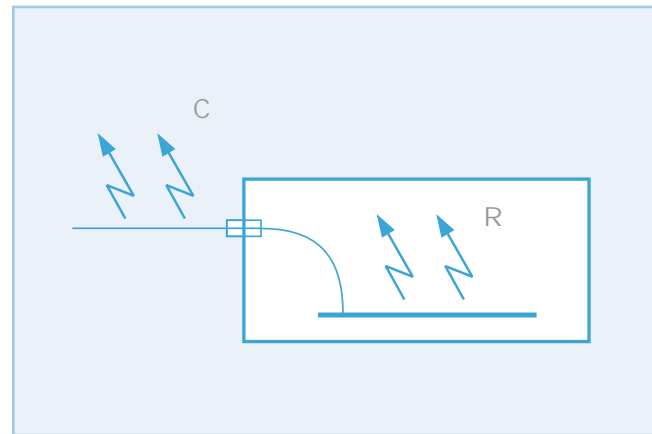

Radiated emissions 'R' are blocked by the casing design.

Conducted emissions & Radiated emissions as a result of conducted emissions 'C' are resolved by using appropriate filters in the case housing.

To define the filter, the ratio of emissions 'C' to the requirements of MIL-STD-461 must be known.

Installation of Filters

Surface Mount and Panel Mount Solder-in filters

Solder pad layouts are included with the detailed information for each part.

Recommended soldering profile

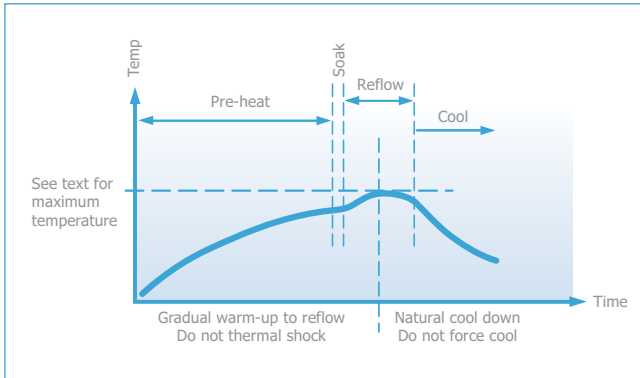

Soldering of filters

The soldering process should be controlled such that the filter does not experience any thermal shocks which may induce thermal cracks in the ceramic dielectric.

The pre-heat temperature rise of the filter should be kept to around 2°C per second. In practice successful temperature rises tend to be in the region of 1.5°C to 4°C per second dependent upon substrate and components.

The introduction of a soak after pre-heat can be useful as it allows temperature uniformity to be established across the substrate thus preventing substrate warping. The magnitude or direction of any warping may change on cooling, imposing damaging stresses upon the filter.

E01, E03, E07 SBSP ranges are compatible with all standard solder types including lead-free, maximum temperature 260°C. For SBSG, SBSM and SFSS ranges, solder time should be minimised, and the temperature controlled to a maximum of 220°C. For SFSR, SFST and SFSU ranges the maximum temperature is 250°C.

Cooling to ambient temperature should be allowed to occur naturally. Natural cooling allows a gradual relaxation of thermal mismatch stresses in the solder joints. Draughts should be avoided. Forced air cooling can induce thermal breakage, and cleaning with cold fluids immediately after a soldering process may result in cracked filters.

Note: The use of FlexiCap™ terminations is strongly recommended to reduce the risk of mechanical cracking.

Soldering to axial wire leads

Soldering temperature

The tip temperature of the iron should not exceed 300°C.

Dwell time

Dwell time should be 3-5 seconds maximum to minimise the risk of cracking the capacitor due to thermal shock.

Heat sink

Where possible, a heat sink should be used between the solder joint and the body, especially if longer dwell times are required.

Bending or cropping of wire leads

Bending or cropping of the filter terminations should not be carried out within 4mm (0.157") of the epoxy encapsulation, the wire should be supported when cropping.

Soldering irons should not be used for mounting surface mount filters as they can result in thermal shock damage to the chip capacitor.

A more comprehensive application note covering installation of all Syfer products is available on the Syfer website.

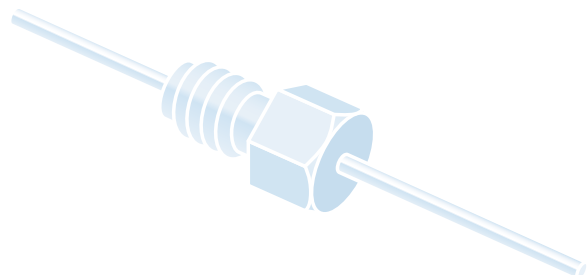
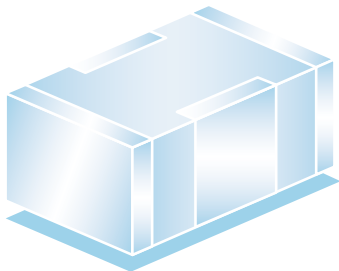
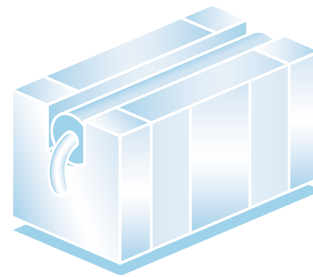
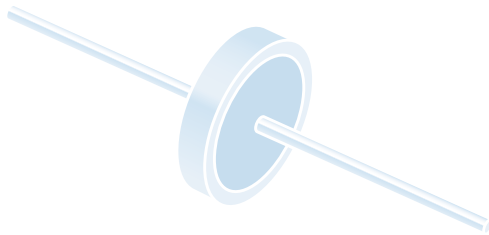

Installation of Filters

Resin filled screw mounted EMI Filters

General

The ceramic capacitor, which is the heart of the filter, can be damaged by thermal and mechanical shock, as well as by over-voltage. Care should be taken to minimise the risk of stress when mounting the filter to a panel and when soldering wire to the filter terminations.

Mounting to Chassis

Mounting Torque

It is important to mount the filter to the bulkhead or panel using the recommended mounting torque, otherwise damage may be caused to the capacitor due to distortion of the case. When a threaded hole is to be utilised, the maximum mounting torque should be 50% of the specified figure which relates to unthreaded holes. For details of torque figures for each filter range, please see below.

Tools

Hexagonal devices should be assembled using a suitable socket. Round bodied filters may be fitted to the panel in one of two ways (and should not be fitted using pliers or other similar tools which may damage them):

- Round bodies with slotted tops are designed to be screwed in using a simple purpose-designed tool.
- Round bodies without slotted tops are intended to be inserted into slotted holes and retained with a nut. The thread has flats machined to engage with the flats in the hole.

Grounding

To ensure the proper operation of the filters, the filter body should be adequately grounded to the panel to allow an effective path for the interference. The use of locking adhesives is not recommended, but if used should be applied after the filter has been fitted.

Minimum plate thickness

Users should be aware that the majority of these filters have an undercut between the thread and the mounting flange of the body, equal to 1.5 x the pitch of the thread. Mounting into a panel thinner than this undercut length may result in problems with thread mating and filter position. It is recommended that a panel thicker than this undercut length be used wherever possible.

Maximum plate thickness

This is specified for each filter in order that the nut can be fully engaged even when using a washer.

Soldering to axial wire leads

Soldering temperature

The tip temperature of the iron should not exceed 300°C.

Dwell time

Dwell time should be 3-5 seconds maximum to minimise the risk of cracking the capacitor due to thermal shock.

Heat sink

Where possible, a heat sink should be used between the solder joint and the body, especially if longer dwell times are required.

Bending or cropping of wire leads

Bending or cropping of the filter terminations should not be carried out within 4mm (0.157") of the epoxy encapsulation, the wire should be supported when cropping.

RoHS Compliance

All surface mount filters, resin sealed panel mount filters and power filters can be supplied fully RoHS compliant (2011/65/EU) through material exemption. Please contact our Sales Office for further details. Care must be taken not to exceed the maximum soldering temperatures of surface mount parts.

Standard hermetic sealed panel mount filters use SnPb solders as part of their assembly and are intended for exempt applications such as aerospace or military. Substitution of the SnPb solder with Pb free solders may be possible to create a RoHS compliant part, subject to quantities – please refer to the Syfer Sales Office for more information.

Introduction to Surface Mount EMI Filters

Surface Mount Filters are designed to be mounted directly to printed circuit boards using conventional mounting techniques in the same way as standard MLCC's.

Solder connections are made to each end (signal lines) and each side band (earth or ground).

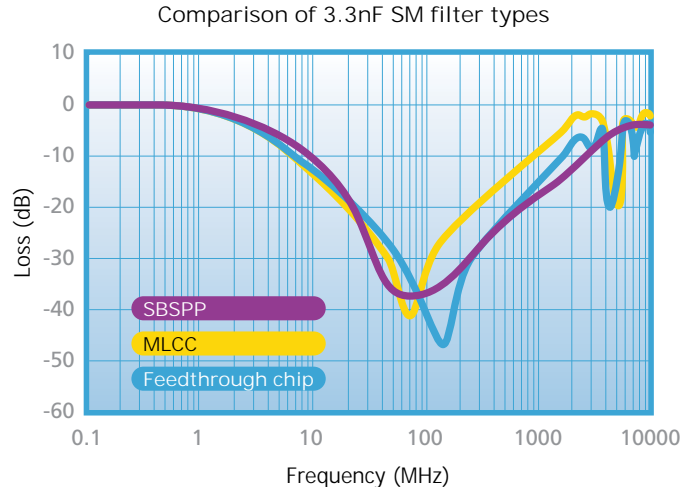

They are categorised into 3 distinct families:

1. E01 / E07 'C' Filter EMI Chips (also known as 3-terminal chips)

These use conventional MLCC manufacturing techniques to form a filter which is short circuit end-to-end and has a capacitance between the end terminals and the side (ground) terminals. The signal is carried through the internal electrodes. The current carrying capacity is defined by the cross section and number of the electrodes in the filter and is therefore linked with the capacitance of the filter.

Compared to conventional 2-terminal MLCC devices the internal inductance between line and ground is reduced, giving improved attenuation.

2. Surface mount 'Pi'/'C' Filters

'Pi' filters incorporate 2 capacitors and an inductor together to make a multi-element filter, giving sharper cut-off and better low frequency performance than straight 'C' filters. The Syfer range of SM 'Pi' filters use conventional MLCC manufacturing techniques to form the capacitive element of the filter, but the inductive element is created separately either by means of a bead inductor placed over a through conductor pin, or by means of a buried layer surface mount inductor with the signal carried by the buried internal layers. Current carrying capacity is defined by the characteristics of the conductor and is independent to the capacitance of the filter.

3. X2Y Filters

X2Y filters are manufactured in the same way as conventional MLCC's but have a special internal architecture that results in ultra-low ESL (Equivalent Series Inductance) through opposing current flows in adjacent parallel plates. They are not feedthrough devices, but act as bypass filters so are not current limited - the only signal passing through the chip is the filtered noise to ground. They are ideal for twin-line applications such as motors, amplifier inputs or twisted pair (balanced line) applications, where they are fitted between the lines with the centre terminal taken to ground. Incorporating the capacitors in a single ceramic element eliminates any capacitance shift through temperature variation.

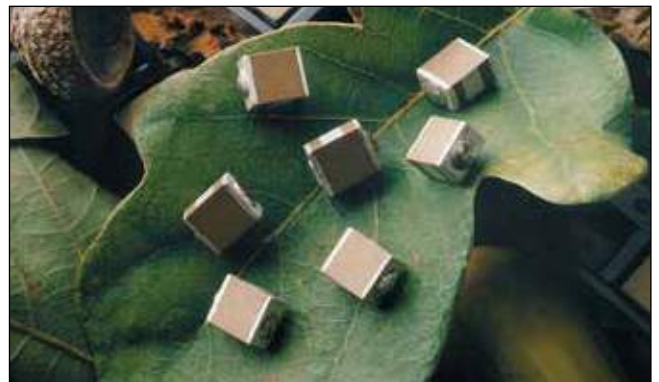

Insertion Loss

Insertion Loss figures

Insertion loss plots and figures supplied are typical only and are measured on 50Ω stripline open boards, 0.8mm thick FR4 with gold plated tracks. Solder pads are 'T' bar with respect to the track and dimensionally match the recommendations given. The boards are mounted to brass support jigs for mechanical stability and electrical grounding. All measurements are taken using a Vector Network Analyser in a 50Ω system, no load.

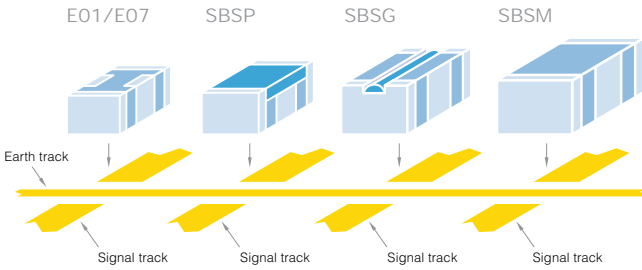

It is important to recognise that the board material, thickness and layout, the plating finish, the grounding efficiency and the circuit impedances will all have an effect on the actual performance of the filter in operation. The effect of the board makes it difficult to directly compare parts unless the mounting details are defined. It is therefore important to test the filters in circuit to determine the performance level achieved.

Filters mounted on open pcb

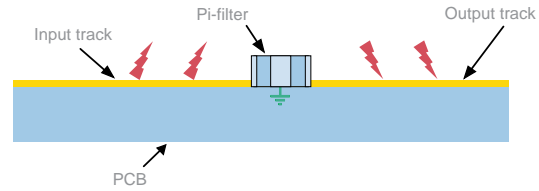

Improved shielding

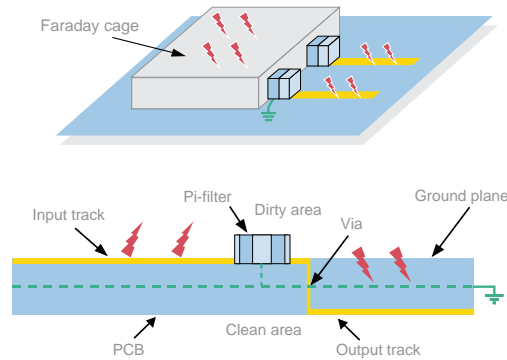

Effects of mounting method on Insertion Loss

'C' and 'Pi' filters are mounted to PCBs and soldered in identical manner to chip capacitors. Solder connections made to each end (signal lines) and each side band (earth track).

Whilst SBSG, SBSM and SBSP filters can be mounted conventionally on PCBs, they are also suitable for mounting in a wall or partition on a board. This greatly improves the screening between filter input and output, thereby enhancing the high frequency response.

The following insertion loss curves based on actual measurements, show the effect. It can be seen that the filters conventionally mounted exhibit a drop in attenuation at higher frequencies. Shielding methods maintain improved suppression characteristics to 1GHz and above.

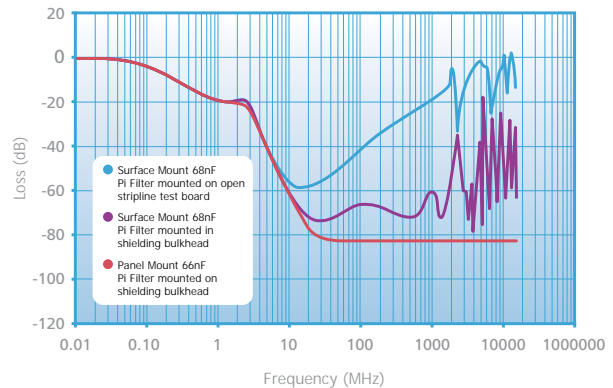

Insertion Loss - SM High Current and Pi Filters

E01 & E07 Insertion Loss

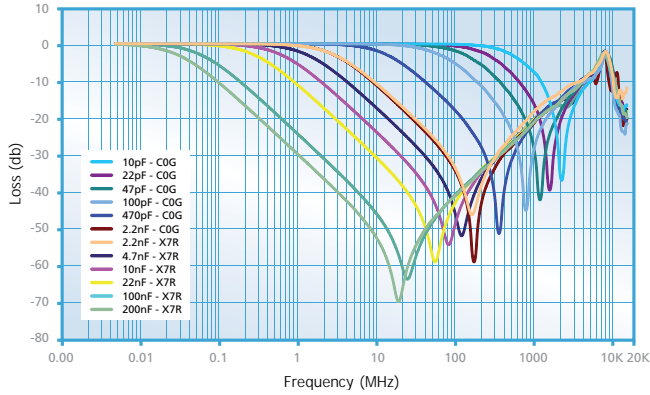

See page 15/16

SBSPP Insertion Loss
Open Board Stripline jig. 50ohm System

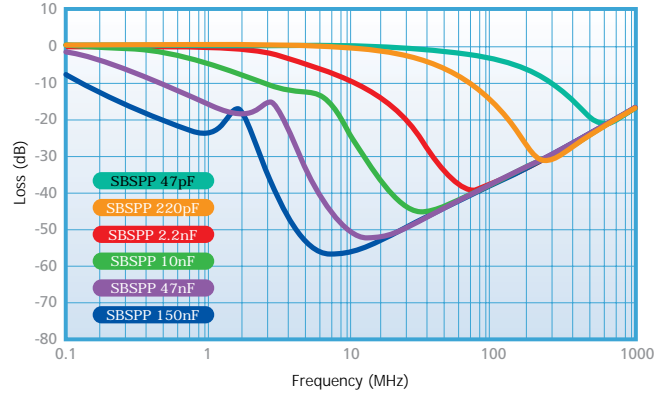

See page 17

SBSGC Insertion Loss
Open Board Stripline jig. 50ohm System

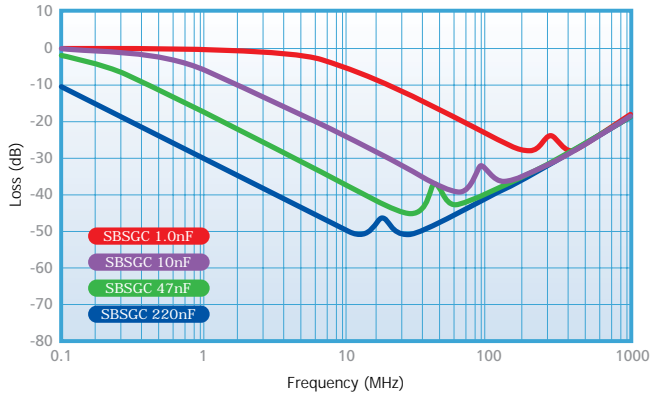

See page 18

SBSGP Insertion Loss
Open Board Stripline jig. 50ohm System

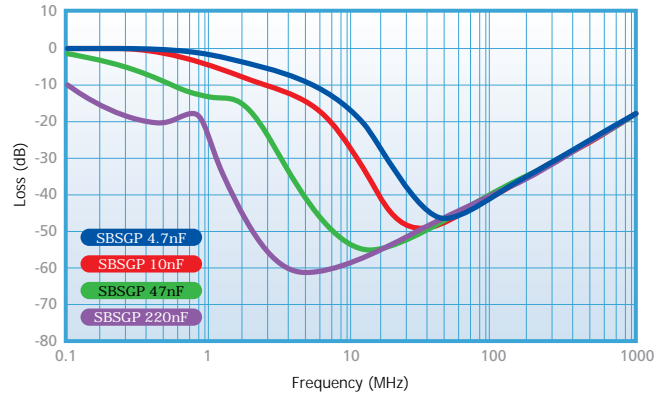

See page 19

SBSMC Insertion Loss
Open Board Stripline jig. 50ohm System

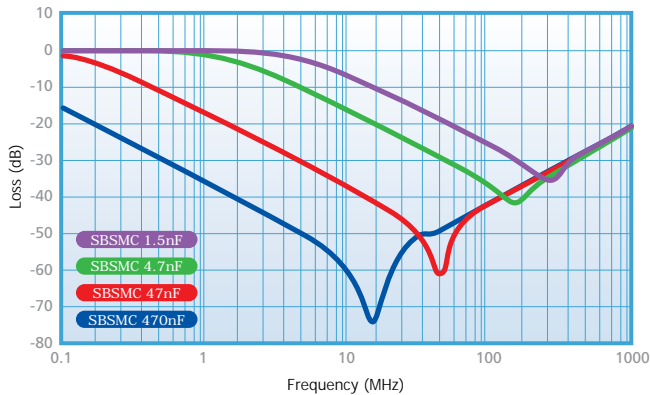

See page 20

SBSMP Insertion Loss
Open Board Stripline jig. 50ohm System

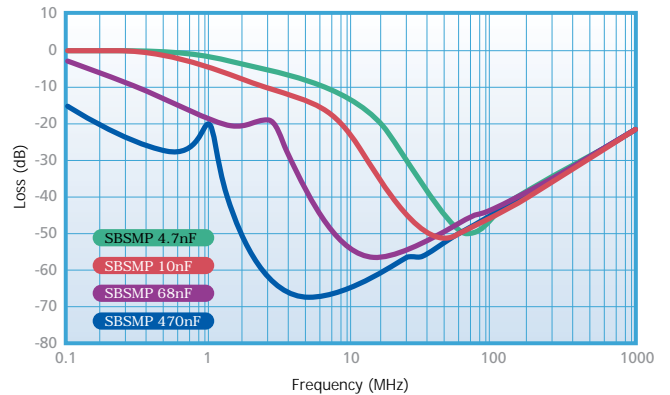

See page 21

Surface Mount EMI Filters - E01 & E07 feedthrough capacitors

EMI chip

The Syfer E01 and E07 ranges of feedthrough MLCC chip 'C' filters are 3 terminal chip devices designed to offer reduced inductance compared to conventional MLCCs when used in signal line filtering.

The filtered signal passes through the chip internal electrodes and the noise is filtered to the grounded side contacts, resulting in reduced length noise transmission paths.

Available in COG/NPO and X7R dielectrics, with current ratings of 300mA, 1A, 2A, 3A and voltage ratings of 25Vdc to 200Vdc. Also available with FlexiCap™ termination which is strongly recommended for new designs.

Commonly used in automotive applications, a range qualified to AEC-Q200 is also available.

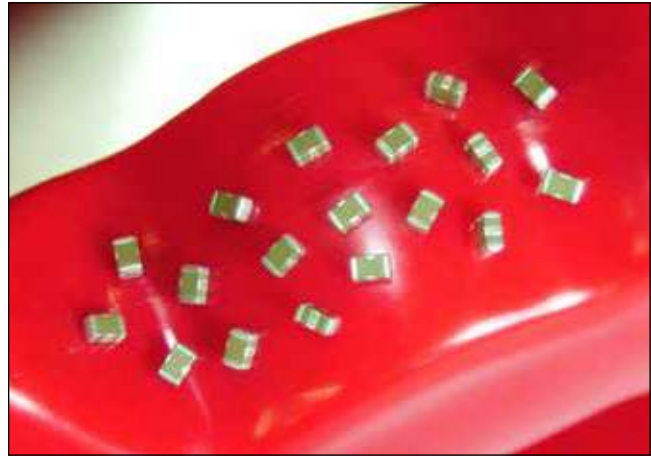

E01 300mA, E07 1A/2A/3A

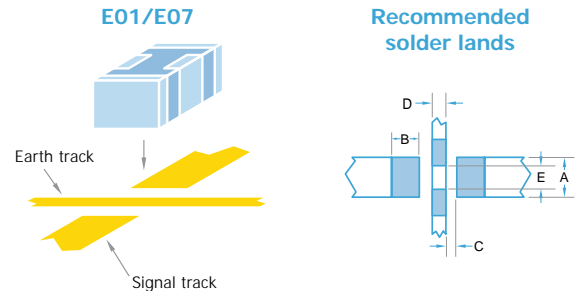
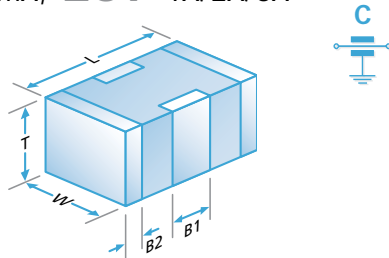

Dimensions

	0805	1206	1806	1812
L	2.0 ± 0.3 (0.079 ± 0.012)	3.2 ± 0.3 (0.126 ± 0.012)	4.5 ± 0.35 (0.177 ± 0.014)	4.5 ± 0.35 (0.177 ± 0.014)
W	1.25 ± 0.2 (0.049 ± 0.008)	1.6 ± 0.2 (0.063 ± 0.008)	1.6 ± 0.2 (0.063 ± 0.008)	3.2 ± 0.3 (0.126 ± 0.012)
T	1.0 ± 0.15 (0.039 ± 0.006)	1.1 ± 0.2 (0.043 ± 0.008)	1.1 ± 0.2 (0.043 ± 0.008)	2.0 ± 0.3 (0.079 ± 0.012)
B1	0.60 ± 0.2 (0.024 ± 0.008)	0.95 ± 0.3 (0.037 ± 0.012)	1.4 ± 0.3 (0.055 ± 0.012)	1.45 ± 0.35 (0.055 ± 0.012)
B2	0.3 ± 0.15 (0.012 ± 0.006)	0.5 ± 0.25 (0.02 ± 0.01)	0.5 ± 0.25 (0.02 ± 0.01)	0.75 ± 0.25 (0.02 ± 0.01)

	0805	1206	1806	1812
A	0.95 (0.037)	1.20 (0.047)	1.2 (0.047)	2.65 (0.104)
B	0.90 (0.035)	0.90 (0.035)	1.40 (0.055)	1.40 (0.055)
C	0.30 (0.012)	0.60 (0.024)	0.80 (0.031)	0.80 (0.031)
D	0.40 (0.016)	0.80 (0.031)	1.40 (0.055)	1.40 (0.055)
E	0.75 (0.030)	1.0 (0.039)	1.0 (0.039)	2.05 (0.080)

- Notes: 1) All dimensions mm (inches).
 2) Pad widths less than chip width gives improved mechanical performance.
 3) The solder stencil should place 4 discrete solder pads. The unprinted distance between ground pads is shown as dim E.
 4) Insulating the earth track underneath the filters is acceptable and can help avoid displacement of filter during soldering but can result in residue entrapment under the chip.

Standard Range - E01 & E07 Feedthrough Capacitors

Type		E01			E07			
Chip Size		0805	1206	1806	0805	1206	1806	1812
Max Current		300mA	300mA	300mA	1A	2A	2A	3A
Rated Voltage	Dielectric	Minimum and maximum capacitance values						
25Vdc	COG/NPO	180pF-1.5nF	560pF-3.9nF	820pF-4.7nF	180pF-1.5nF	560pF-3.9nF	820pF-4.7nF	-
	X7R	470pF-100nF	5.6nF-330nF	3.9nF-560nF	820pF-100nF	10nF-330nF	22nF-560nF	560nF-1.8µF
50Vdc	COG/NPO	22pF-820pF	22pF-3.3nF	22pF-3.9nF	10pF-220pF	22pF-1nF	100pF-1.5nF	-
	X7R	560pF-68nF	4.7nF-220nF	3.3nF-330nF	1nF-68nF	10nF-220nF	22nF-330nF	330nF-1.5µF
100Vdc	COG/NPO	22pF-560pF	22pF-2.2nF	22pF-3.3nF	10pF-120pF	22pF-560pF	100pF-680pF	-
	X7R	560pF-27nF	1.8nF-100nF	3.3nF-180nF	1nF-27nF	10nF-100nF	22nF-180nF	180nF-820nF
200Vdc	COG/NPO	-	560pF-1.2nF	56pF-1nF	-	15pF-180pF	56pF-470pF	-
	X7R	-	2.7nF-56nF	3.9nF-100nF	-	12nF-56nF	22nF-100nF	100nF-270nF

Note: E07 25Vdc COG/NPO 1206 and 1806 ranges in green, have maximum current of 1A.

AEC-Q200 Qualified Range - E01 & E07 Feedthrough Capacitors - maximum capacitance values

Type		E01			E07		
Chip Size		0805	1206	1806	0805	1206	1806
50V	COG/NPO	820pF	1nF	2.2nF	220pF	1nF	1.5nF
	X7R	47nF	100nF	200nF	47nF	100nF	200nF
100V	COG/NPO	560pF	1nF	2.2nF	120pF	560pF	680pF
	X7R	15nF	15nF	68nF	15nF	15nF	68nF

Notes: ■ = AEC-Q200. For some lower capacitance parts, higher voltage rated parts may be supplied.

Surface Mount EMI Filters - E01 & E07 feedthrough capacitors

Open board insertion loss performance in 50Ω system

Open Board Performance						
Capacitance	0.1MHz	1MHz	10MHz	100MHz	1GHz	Resonance Freq (MHz) approx.
10pF	0	0	0	0	7.5	2200
22pF	0	0	0	0	16	1600
33pF	0	0	0	1	22	1350
47pF	0	0	0	2	28	1150
68pF	0	0	0	3	41	900
100pF	0	0	0	5	28	800
150pF	0	0	0	8	24	700
220pF	0	0	0	12	20	600
330pF	0	0	1	15	20	500
470pF	0	0	2	18	20	425
560pF	0	0	3	20	20	350
680pF	0	0	4	22	20	300
820pF	0	0	5	24	20	260
1nF	0	0	7	27	20	220
1.5nF	0	0	9	31	20	200
2.2nF	0	0	12	34	20	170
3.3nF	0	1	14	39	20	135
4.7nF	0	2	18	46	20	110
6.8nF	0	3	21	50	20	90
10nF	0	5	24	48	20	80
15nF	0	8	27	45	20	65
22nF	0	12	31	43	20	56
33nF	1	14	34	40	20	40
47nF	2	17	38	40	20	34
68nF	4	20	41	40	20	30
100nF	6	24	45	40	20	28
150nF	8	26	48	40	20	24
220nF	10	30	52	40	20	17
330nF	13	33	55	40	20	15.5
470nF	16	36	60	40	20	14
560nF	18	39	65	40	20	12

Note: For Insertion Loss graph see page 14.

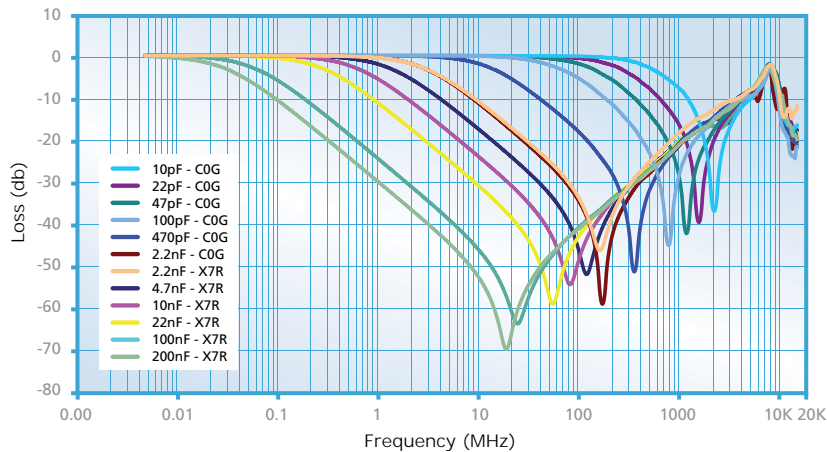

Ordering Information - E01 & E07 feedthrough capacitors

1206	Y	100	0103	M	X	T	E07
Chip size	Termination	Voltage	Capacitance in picofarads (pF)	Tolerance	Dielectric	Packaging	Type
0805 1206 1806 1812	J = Nickel Barrier (Tin) *Y = FlexiCap™ (Tin - X7R only) A = (Tin/Lead) Not RoHS compliant. *H = FlexiCap™ (Tin/Lead) Not RoHS compliant.	025 = 25V 050 = 50V 100 = 100V 200 = 200V	First digit is 0. Second and third digits are significant figures of capacitance code. The fourth digit is number of zeros following Example: 0103 = 10000pF.	M = ±20%	A = COG/NP0 AEC-Q200 C = COG/NP0 E = X7R AEC-Q200 X = X7R	T = 178mm (7") reel R = 330mm (13") reel B = Bulk	E01 E07

Note: *FlexiCap™ termination only available in X7R material. Please contact our Sales Office for any special requirements.

Reeled quantities

178mm (7") reel	0805	1206	1806	1812	330mm (13") reel	0805	1206	1806	1812
	3000	2500	2500	500		12000	10000	10000	2000

Dimensions

L	3.20±0.3 (0.126"±0.012")
W	1.65±0.3 (0.065"±0.012")
T	1.60±0.20 (0.063"±0.008")
B1	0.95±0.3 (0.037"±0.012")
B2	0.50±0.25 (0.020"±0.010")

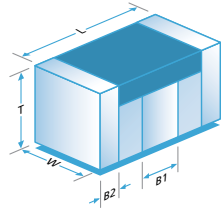

Suggested mounting pad details

E = Unprinted solder area between ground pads

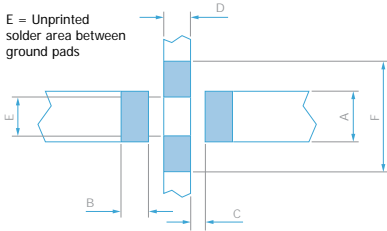

A	1.20 (0.047")
B	0.90 (0.035")
C	0.60 (0.024")
D	0.80 (0.030")
E	1.00 (0.039")
F	2.90 (0.114")

It is recommended that designers independently confirm pad dimensions are acceptable, particularly with respect to higher working voltages.

Electrical Details

Electrical Configuration	PI Filter
Capacitance Measurement	@ 1000hr Point
Current Rating	1A
Insulation Resistance (IR)	10GΩ or 1000ΩF
Temperature Rating	-55°C to +125°C
Ferrite Inductance (Typical)	0.30μH (@ 1MHz)

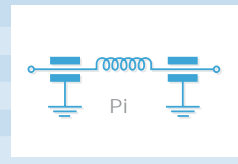

Mechanical Details

Terminals & Finish - End & Side	Sn plated over FlexiCap™ Termination
Construction	Ceramic Multi Layer Chip Capacitor Multi Layer Ferrite Bead Inductor Connection via FlexiCap™ Termination
Weight (Typical)	0.07g (0.0025oz)

Reeled quantities

	SBSPP
178mm (7") reel	1500

Product Code	Capacitance (±20%)	Dielectric	Rated Voltage (dc)	DWV (dc)	Approximate Resonant Frequency (MHz)	Typical No-Load Insertion Loss (dB) *				
						0.1MHz	1MHz	10MHz	100MHz	1GHz
SBSPP1000220MC	22pF	COG/NPO	100	250	1000	0	0	0	2	22
SBSPP1000470MC	47pF		100	250	620	0	0	0	4	16
SBSPP1000101MC	100pF		100	250	400	0	0	0	7	14
SBSPP1000221MC	220pF		100	250	260	0	0	1	14	12
SBSPP1000471MC	470pF		100	250	180	0	0	2	25	16
SBSPP1000102MX	1.0nF	X7R	100	250	120	0	0	4	37	16
SBSPP1000152MX	1.5nF		100	250	90	0	0	7	37	16
SBSPP1000222MX	2.2nF		100	250	72	0	0	9	37	16
SBSPP1000332MX	3.3nF		100	250	59	0	1	13	37	16
SBSPP1000472MX	4.7nF		100	250	50	0	2	14	37	16
SBSPP1000682MX	6.8nF		100	250	38	0	4	24	37	16
SBSPP1000103MX	10nF		100	250	33	0	5	24	37	16
SBSPP1000153MX	15nF		100	250	26	0	8	32	37	16
SBSPP0500223MX	22nF		50	125	21	0	10	38	37	16
SBSPP0500333MX	33nF		50	125	17	1	13	46	37	16
SBSPP0500473MX	47nF		50	125	13	2	16	50	37	16
SBSPP0500683MX	68nF		50	125	10	3	20	54	37	16
SBSPP0500104MX	100nF		25	67.5	8.5	6	19	52	37	16
SBSPP0500154MX	150nF		25	67.5	7	8	24	56	37	16

* Insertion Loss performance quoted is measured on an open FR4 board mounted on a brass backplane in a 50Ω system. Performance curves can be supplied on request. Performance in circuit is liable to be different and is affected by board material, track layout, grounding efficiency and circuit impedances. Shielding can be used to improve high frequency performance.

Ordering Information - SBSPP range

SB	S	P	P	100	0153	M	X	B
Type	Case style	Size	Electrical configuration	Voltage (dc)	Capacitance in picofarads (pF)	Tolerance	Dielectric	Packaging
Syfer Board Filter	Surface Mount	Size Code P (nominally 1206)	P = Pi Filter	025 = 25V 050 = 50V 100 = 100V	First digit is 0. Second and third digits are significant figures of capacitance code. The fourth digit is number of zeros following Example: 0472 = 4700pF 0153 = 15000pF	M = ±20%	C = COG/NPO X = X7R	T=178mm (7") reel R=330mm (13") reel B = Bulk

Note: The addition of a 4-digit numerical suffix code can be used to denote changes to the standard part. Options include for example: change of finish / alternative voltage rating / non-standard intermediate capacitance values / test requirements. Please refer specific requests to the factory.

Dimensions

L1	4.55±0.25 (0.179"±0.010")
L2	4.70±0.4 (0.185"±0.015")
W	3.20±0.2 (0.126"±0.008")
T	2.50±0.15 (0.098"±0.006")
B1	1.50±0.4 (0.059"±0.015")
B2	0.30±0.25 (0.012"±0.010")

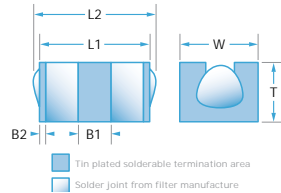

Suggested mounting pad details

E = Unprinted solder area between ground pads

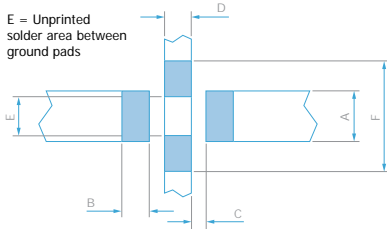

A	2.65 (0.104")
B	1.40 (0.055")
C	0.08 (0.031")
D	1.40 (0.055")
E	2.05 (0.080")
F	5.80 (0.228")

It is recommended that designers independently confirm pad dimensions are acceptable, particularly with respect to higher working voltages.

Electrical Details

Electrical Configuration	C Filter
Capacitance Measurement	@ 1000hr Point
Current Rating	10A
Insulation Resistance (IR)	10GΩ or 1000ΩF
Temperature Rating	-55°C to +125°C
Ferrite Inductance (Typical)	N/A

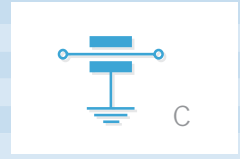

Mechanical Details

Terminals & Finish - End	SnAg solder over Sn Plate
Terminals & Finish - Side	Sn Plated
Reflow Temperature	220°C max.
Construction	Ceramic Multi Layer Chip Capacitor Copper Alloy Through Conductor Soldered End Connections
Weight (Typical)	0.20g (0.007oz)

Reeled quantities

178mm (7") reel	SBSGC 500
-----------------	---------------------

Product Code	Capacitance (±20%)	Dielectric	Rated Voltage (dc)	DWV (dc)	Approximate Resonant Frequency (MHz)	Typical No-Load Insertion Loss (dB) *				
						0.1MHz	1MHz	10MHz	100MHz	1GHz
SBSGC5000102MX	1.0nF	X7R	500	750	186	0	0	5	23	18
SBSGC5000152MX	1.5nF		500	750	147	0	0	8	27	18
SBSGC5000222MX	2.2nF		500	750	130	0	0	11	32	18
SBSGC5000332MX	3.3nF		500	750	110	0	1	14	34	18
SBSGC5000472MX	4.7nF		500	750	100	0	2	17	40	18
SBSGC5000682MX	6.8nF		500	750	80	0	4	20	38	18
SBSGC5000103MX	10nF		500	750	62.5	0	5	24	38	18
SBSGC5000153MX	15nF		500	750	50	0	8	27	38	18
SBSGC5000223MX	22nF		500	750	39	0	11	32	39	18
SBSGC5000333MX	33nF		500	750	33	1	14	34	39	18
SBSGC5000473MX	47nF		500	750	28	2	17	36	39	18
SBSGC2000683MX	68nF		200	500	23	3	20	37	39	18
SBSGC1000104MX	100nF		100	250	19	5	23	41	39	18
SBSGC1000154MX	150nF		100	250	15.5	8	27	47	39	18
SBSGC0500224MX	220nF		50	125	13	11	30	49	39	18

* Insertion Loss performance quoted is measured on an open FR4 board mounted on a brass backplane in a 50Ω system. Performance curves can be supplied on request. Performance in circuit is liable to be different and is affected by board material, track layout, grounding efficiency and circuit impedances. Shielding can be used to improve high frequency performance.

Ordering Information - SBSGC range

SB	S	G	C	500	0473	M	X	B
Type	Case style	Size	Electrical configuration	Voltage (dc)	Capacitance in picofarads (pF)	Tolerance	Dielectric	Packaging
Syfer Board Filter	Surface Mount	Size Code G (nominally 1812)	C = C Filter	050 = 50V 100 = 100V 200 = 200V 500 = 500V	First digit is 0. Second and third digits are significant figures of capacitance code. The fourth digit is number of zeros following Example: 0472 = 4700pF 0683 = 68000pF	M = ±20%	X = X7R	T = 178mm (7") reel R = 330mm (13") reel B = Bulk

Note: The addition of a 4-digit numerical suffix code can be used to denote changes to the standard part. Options include for example: change of finish / alternative voltage rating / non-standard intermediate capacitance values / test requirements. Please refer specific requests to the factory.

Dimensions

L1	4.55±0.25 (0.179"±0.010")
L2	5.25±0.4 (0.207"±0.015")
W	3.20±0.2 (0.126"±0.008")
T	2.50±0.15 (0.098"±0.006")
B1	1.50±0.4 (0.059"±0.015")
B2	0.30±0.25 (0.012"±0.010")

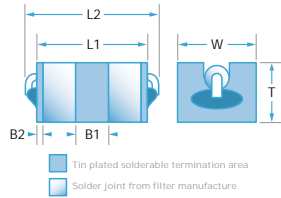

Suggested mounting pad details

E = Unprinted solder area between ground pads

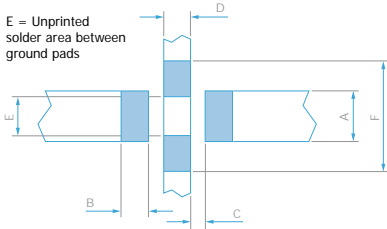

A	2.65 (0.104")
B	1.40 (0.055")
C	0.80 (0.031")
D	1.40 (0.055")
E	2.05 (0.080")
F	5.80 (0.228")

It is recommended that designers independently confirm pad dimensions are acceptable, particularly with respect to higher working voltages.

Electrical Details

Electrical Configuration	Pi Filter
Capacitance Measurement	@ 1000hr Point
Current Rating	5A
Insulation Resistance (IR)	10GΩ or 1000ΩF
Temperature Rating	-55°C to +125°C
Ferrite Inductance (Typical)	0.7μH (@ 100kHz)

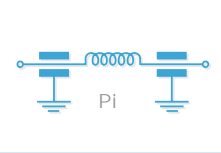

Mechanical Details

Terminals & Finish - End	SnAg solder over Sn Plate
Terminals & Finish - Side	Sn Plated
Reflow Temperature	220°C max.
Construction	Ceramic Multi Layer Chip Capacitor Copper Alloy Through Conductor Ferrite Bead Inductor Soldered End Connections
Weight (Typical)	0.20g (0.007oz)

Reeled quantities

	SBSGP
178mm (7") reel	500

Product Code	Capacitance (±20%)	Dielectric	Rated Voltage (dc)	DWV (dc)	Approximate Resonant Frequency (MHz)	Typical No-Load Insertion Loss (dB)*				
						0.1MHz	1MHz	10MHz	100MHz	1GHz
SBSGP5000102MX	1.0nF	X7R	500	750	140	0	0	5	39	18
SBSGP5000152MX	1.5nF		500	750	100	0	0	8	41	18
SBSGP5000222MX	2.2nF		500	750	75	0	0	10	39	18
SBSGP5000332MX	3.3nF		500	750	54	0	1	15	39	18
SBSGP5000472MX	4.7nF		500	750	44	0	2	17	39	18
SBSGP5000682MX	6.8nF		500	750	35	0	3	23	39	18
SBSGP5000103MX	10nF		500	750	28	0	5	28	39	18
SBSGP5000153MX	15nF		500	750	23	0	8	35	39	18
SBSGP5000223MX	22nF		500	750	19	0	10	43	39	18
SBSGP5000333MX	33nF		500	750	15	1	12	46	39	18
SBSGP5000473MX	47nF		500	750	12	2	14	53	39	18
SBSGP2000683MX	68nF		200	500	10	3	16	55	39	18
SBSGP1000104MX	100nF		100	250	7.5	5	17	56	39	18
SBSGP1000154MX	150nF		100	250	6	8	20	58	39	18
SBSGP0500224MX	220nF		50	125	5.2	11	25	58	39	18

* Insertion Loss performance quoted is measured on an open FR4 board mounted on a brass backplane in a 50Ω system. Performance curves can be supplied on request. Performance in circuit is liable to be different and is affected by board material, track layout, grounding efficiency and circuit impedances. Shielding can be used to improve high frequency performance.

Ordering Information - SBSGP range

SB	S	G	P	050	0224	M	X	B
Type	Case style	Size	Electrical configuration	Voltage (dc)	Capacitance in picofarads (pF)	Tolerance	Dielectric	Packaging
Syfer Board Filter	Surface Mount	Size Code G (nominally 1812)	P = Pi Filter	050 = 50V 100 = 100V 200 = 200V 500 = 500V	First digit is 0. Second and third digits are significant figures of capacitance code. The fourth digit is number of zeros following Example: 0472 = 4700pF 0683 = 68000pF	M = ±20%	X = X7R	T = 178mm (7") reel R = 330mm (13") reel B = Bulk

Note: The addition of a 4-digit numerical suffix code can be used to denote changes to the standard part. Options include for example: change of finish / alternative voltage rating / non-standard intermediate capacitance values / test requirements. Please refer specific requests to the factory.

Dimensions

L1	5.7±0.4 (0.224"±0.015")
L2	6.6±0.4 (0.260"±0.015")
W	5.0±0.4 (0.197"±0.015")
T	3.18±0.2 (0.125"±0.008")
B1	2.25±0.4 (0.088"±0.015")
B2	0.30±0.25 (0.012"±0.010")

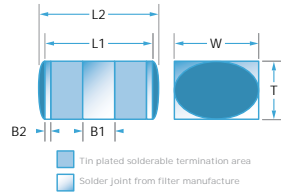

Suggested mounting pad details

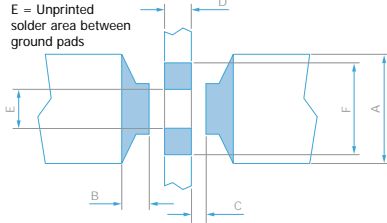

A	10.00 (0.394")
B	2.35 (0.093")
C	1.35 (0.053")
D	2.00 (0.079")
E	3.95 (0.156")
F	7.80 (0.307")

It is recommended that designers independently confirm pad dimensions are acceptable, particularly with respect to higher working voltages.

Electrical Details

Electrical Configuration	C Filter
Capacitance Measurement	@ 1000hr Point
Current Rating	20A
Insulation Resistance (IR)	10GΩ or 1000ΩF
Temperature Rating	-55°C to +125°C
Ferrite Inductance (Typical)	N/A (C' Section)

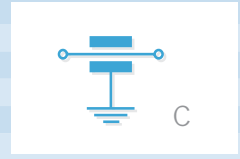

Mechanical Details

Terminals & Finish - End	SnCu solder over Sn Plate
Terminals & Finish - Side	Sn Plated
Reflow Temperature	220°C max.
Construction	Ceramic Multi Layer Chip Capacitor Copper Alloy Through Conductor Soldered End Connections
Weight (Typical)	0.65g (0.023oz)

Reeled quantities

	SBSMC
178mm (7") reel	500

Product Code	Capacitance (±20%)	Dielectric	Rated Voltage (dc)	DWV (dc)	Approximate Resonant Frequency (MHz)	Typical No-Load Insertion Loss (dB)*				
						0.1MHz	1MHz	10MHz	100MHz	1GHz
SBSMC5000152MX	1.5nF	X7R	500	750	265	0	0	7	25	21
SBSMC5000222MX	2.2nF		500	750	235	0	0	11	31	21
SBSMC5000332MX	3.3nF		500	750	185	0	1	15	35	21
SBSMC5000472MX	4.7nF		500	750	154	0	2	17	40	21
SBSMC5000682MX	6.8nF		500	750	125	0	4	21	44	21
SBSMC5000103MX	10nF		500	750	100	0	5	24	50	21
SBSMC5000153MX	15nF		500	750	80	0	7	27	43	21
SBSMC5000223MX	22nF		500	750	65	0	11	31	43	21
SBSMC5000333MX	33nF		500	750	54	1	15	34	43	21
SBSMC5000473MX	47nF		500	750	46	2	17	37	43	21
SBSMC5000683MX	68nF		500	750	39	3	21	41	43	21
SBSMC2000104MX	100nF		200	500	33	5	24	44	43	21
SBSMC2000154MX	150nF		200	500	26	7	26	47	43	21
SBSMC1000224MX	220nF		100	250	21	11	31	52	43	21
SBSMC1000334MX	330nF		100	250	20	14	33	54	43	21
SBSMC0500474MX	470nF		50	125	19	17	36	54	43	21

* Insertion Loss performance quoted is measured on an open FR4 board mounted on a brass backplane in a 50Ω system. Performance curves can be supplied on request. Performance in circuit is liable to be different and is affected by board material, track layout, grounding efficiency and circuit impedances. Shielding can be used to improve high frequency performance.

Ordering Information - SBSMC range

SB	S	M	C	100	0334	M	X	B
Type	Case style	Size	Electrical configuration	Voltage (dc)	Capacitance in picofarads (pF)	Tolerance	Dielectric	Packaging
Syfer Board Filter	Surface Mount	Size Code M (nominally 2220)	C = C Filter	050 = 50V 100 = 100V 200 = 200V 500 = 500V	First digit is 0. Second and third digits are significant figures of capacitance code. The fourth digit is number of zeros following Example: 0472 = 4700pF 0683 = 6800pF	M = ±20%	X = X7R	T = 178mm (7") reel R = 330mm (13") reel B = Bulk

Note: The addition of a 4-digit numerical suffix code can be used to denote changes to the standard part. Options include for example: change of finish / alternative voltage rating / non-standard intermediate capacitance values / test requirements. Please refer specific requests to the factory.

Dimensions

L1	5.7±0.4 (0.224"±0.015")
L2	6.6±0.4 (0.260"±0.015")
W	5.0±0.4 (0.197"±0.015")
T	3.18±0.2 (0.125"±0.008")
B1	2.25±0.4 (0.088"±0.015")
B2	0.30±0.25 (0.012"±0.010")

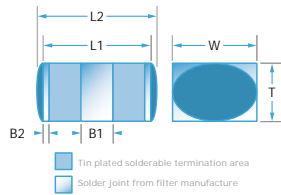

Suggested mounting pad details

E = Unprinted solder area between ground pads

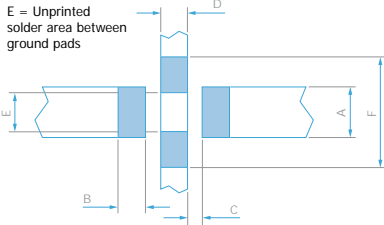

A	5.00 (0.197")
B	2.35 (0.093")
C	1.35 (0.053")
D	2.00 (0.079")
E	3.95 (0.156")
F	7.80 (0.307")

It is recommended that designers independently confirm pad dimensions are acceptable, particularly with respect to higher working voltages.

Electrical Details

Electrical Configuration	Pi Filter
Capacitance Measurement	@ 1000hr Point
Current Rating	10A
Insulation Resistance (IR)	10GΩ or 1000ΩF
Temperature Rating	-55°C to +125°C
Ferrite Inductance (Typical)	0.22μH (@ 100kHz)

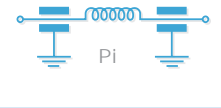

Mechanical Details

Terminals & Finish - End	SnCu solder over Sn Plate
Terminals & Finish - Side	Sn Plated
Reflow Temperature	220°C max.
Construction	Ceramic Multi Layer Chip Capacitor Copper Alloy Through Conductor Ferrite Bead Inductor Soldered End Connections
Weight (Typical)	0.6g (0.021oz)

Reeled quantities

	SBSMP
178mm (7") reel	500

Product Code	Capacitance (±20%)	Dielectric	Rated Voltage (dc)	DWV (dc)	Approximate Resonant Frequency (MHz)	Typical No-Load Insertion Loss (dB) *				
						0.1MHz	1MHz	10MHz	100MHz	1GHz
SBSMP5000152MX	1.5nF	X7R	500	750	130	0	0	7	39	21
SBSMP5000222MX	2.2nF		500	750	100	0	0	11	38	21
SBSMP5000332MX	3.3nF		500	750	80	0	1	12	44	21
SBSMP5000472MX	4.7nF		500	750	63	0	2	15	44	21
SBSMP5000682MX	6.8nF		500	750	55	0	3	18	44	21
SBSMP5000103MX	10nF		500	750	43	0	5	24	44	21
SBSMP5000153MX	15nF		500	750	35	0	8	28	44	21
SBSMP5000223MX	22nF		500	750	30	0	10	35	44	21
SBSMP5000333MX	33nF		500	750	23	1	12	48	44	21
SBSMP5000473MX	47nF		500	750	19	2	16	50	44	21
SBSMC5000683MX	68nF		500	750	15	3	19	55	44	21
SBSMP2000104MX	100nF		200	500	12	5	21	58	44	21
SBSMP2000154MX	150nF		200	500	10	8	23	62	44	21
SBSMP1000224MX	220nF		100	250	8	11	25	63	44	21
SBSMP1000334MX	330nF		100	250	6	14	22	62	44	21
SBSMP0500474MX	470nF		50	125	5	16	20	64	44	21

* Insertion Loss performance quoted is measured on an open FR4 board mounted on a brass backplane in a 50Ω system. Performance curves can be supplied on request. Performance in circuit is liable to be different and is affected by board material, track layout, grounding efficiency and circuit impedances. Shielding can be used to improve high frequency performance.

Ordering Information - SBSMP range

SB	S	M	P	500	0473	M	X	B
Type	Case style	Size	Electrical configuration	Voltage (dc)	Capacitance in picofarads (pF)	Tolerance	Dielectric	Packaging
Syfer Board Filter	Surface Mount	Size Code M (nominally 2220)	P = Pi Filter	050 = 50V 100 = 100V 200 = 200V 500 = 500V	First digit is 0. Second and third digits are significant figures of capacitance code. The fourth digit is number of zeros following Example: 0472 = 4700pF 0683 = 68000pF	M = ±20%	X = X7R	T = 178mm (7") reel R = 330mm (13") reel B = Bulk

Note: The addition of a 4-digit numerical suffix code can be used to denote changes to the standard part. Options include for example: change of finish / alternative voltage rating / non-standard intermediate capacitance values / test requirements. Please refer specific requests to the factory.

Surface Mount EMI Filters - E03 X2Y Integrated Passive Components

The Syfer X2Y Integrated Passive Component is a 3 terminal EMI chip device.

When used in balanced line applications, the revolutionary design provides simultaneous line-to-line and line-to-ground filtering, using a single ceramic chip. In this way, differential and common mode filtering are provided in one device.

For unbalanced applications, it provides ultra low ESL (equivalent series inductance). Capable of replacing 2 or more conventional devices, it is ideal for balanced and unbalanced lines, twisted pairs and dc motors, in automotive, audio, sensor and other applications.

Available in sizes from 0805 to 1812, these filters can prove invaluable in meeting stringent EMC demands.

Manufactured by Knowles Capacitors under licence from X2Y Attenuators LLC.

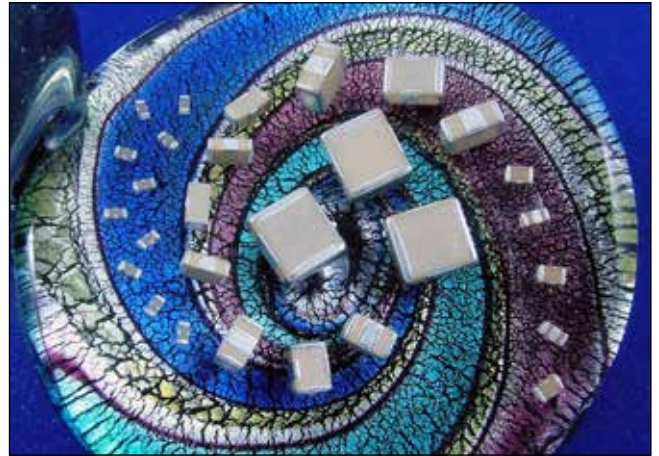

Dielectric

X7R or COG/NPO

Electrical configuration

Multiple capacitance

Capacitance measurement

At 1000hr point

Typical capacitance matching

Better than 5%
(down to 1% available on request)

Temperature rating

-55°C to 125°C

Insulation resistance

100Gohms or 1000s (whichever is the less)

Dielectric withstand voltage

≤200V 2.5 times rated Volts for 5 secs
500V 1.5 times rated Volts for 5 secs
Charging current limited to 50mA Max.

Type		E03			
Chip size		0805	1206	1410	1812
Rated voltage	Dielectric				
25Vdc	COG/NPO	560pF - 820pF	1.8nF - 3.3nF	6.8nF - 8.2nF	12nF - 15nF
	X7R	56nF - 68nF	-	470nF	820nF
50Vdc	COG/NPO	390pF - 470pF	1.2nF - 1.5nF	4.7nF - 5.6nF	8.2nF - 10nF
	X7R	18nF - 47nF	56nF - 220nF	180nF - 400nF	390nF - 680nF
100Vdc	COG/NPO	10pF - 330pF	22pF - 1.0nF	100pF - 3.9nF	820pF - 6.8nF
	X7R	470pF - 15nF	1.5nF - 47nF	4.7nF - 150nF	8.2nF - 330nF
200Vdc	COG/NPO	-	22pF - 1.0nF	100pF - 3.3nF	820pF - 5.6nF
	X7R	-	820pF - 33nF	1.2nF - 120nF	2.7nF - 180nF
500Vdc	COG/NPO	-	-	-	820pF - 3.9nF
	X7R	-	-	-	2.7nF - 100nF

Note: For some lower capacitance parts, higher voltage rated parts may be supplied.

AEC-Q200 range (E03) - capacitance values

Chip size		0805	1206	1410	1812
50Vdc	COG/NPO	390pF - 470pF	1.2nF - 1.5nF	4.7nF - 5.6nF	8.2nF - 10nF
	X7R	18nF - 33nF	56nF - 150nF	180nF - 330nF	390nF - 560nF
100Vdc	COG/NPO	10pF - 330pF	22pF - 1.0nF	100pF - 3.9nF	820pF - 6.8nF
	X7R	470pF - 15nF	1.5nF - 47nF	4.7nF - 150nF	8.2nF - 330nF

Note: = AEC-Q200.

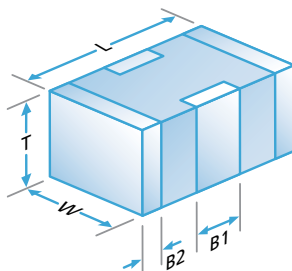

	0805	1206	1410	1812
L	2.0±0.3 (0.08±0.012)	3.2±0.3 (0.126±0.012)	3.6±0.3 (0.14±0.012)	4.5±0.35 (0.18±0.014)
W	1.25±0.2 (0.05±0.008)	1.60±0.2 (0.063±0.008)	2.5±0.3 (0.1±0.012)	3.2±0.3 (0.126±0.012)
T	1.0±0.15 (0.04±0.006)	1.1±0.2 (0.043±0.008)	2.0 max. (0.08 max.)	2.1 max. (0.08 max.)
B1	0.5±0.25 (0.02±0.01)	0.95±0.3 (0.037±0.012)	1.20±0.3 (0.047±0.012)	1.4±0.35 (0.06±0.014)
B2	0.3±0.15 (0.012±0.006)	0.5±0.25 (0.02±0.01)	0.5±0.25 (0.02±0.01)	0.75±0.25 (0.03±0.01)

- Notes: 1) All dimensions mm (inches).
 2) Pad widths less than chip width gives improved mechanical performance.
 3) The solder stencil should place 4 discrete solder pads. The un-printed distance between ground pads is shown as dim E.
 4) Insulating the earth track underneath the filters is acceptable and can help avoid displacement of filter during soldering but can result in residue entrapment under the chip.

Recommended solder lands

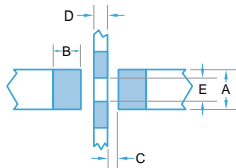

	0805	1206	1410	1812
A	0.95 (0.037)	1.2 (0.047)	2.05 (0.08)	2.65 (0.104)
B	0.9 (0.035)	0.9 (0.035)	1.0 (0.040)	1.4 (0.055)
C	0.3 (0.012)	0.6 (0.024)	0.7 (0.028)	0.8 (0.031)
D	0.4 (0.016)	0.8 (0.031)	0.9 (0.035)	1.4 (0.055)
E	0.75 (0.030)	1.0 (0.039)	1.85 (0.071)	2.05 (0.080)

Component	Advantages	Disadvantages	Applications
Chip capacitor	Industry standard	Requires 1 per line High inductance Capacitance matching problems	By-pass Low frequency
3 terminal feedthrough	Feedthrough Lower inductance	Current limited	Feedthrough Unbalanced lines High frequency
Syfer X2Y Integrated Passive Component	Very low inductance Replaces 2 (or 3) components Negates the effects of temperature, voltage and ageing Provides both common mode and differential mode attenuation Can be used on balanced & unbalanced lines	Care must be taken to optimise circuit design	By-pass Balanced lines High frequency dc electric motors Unbalanced lines Audio amplifiers CANBUS

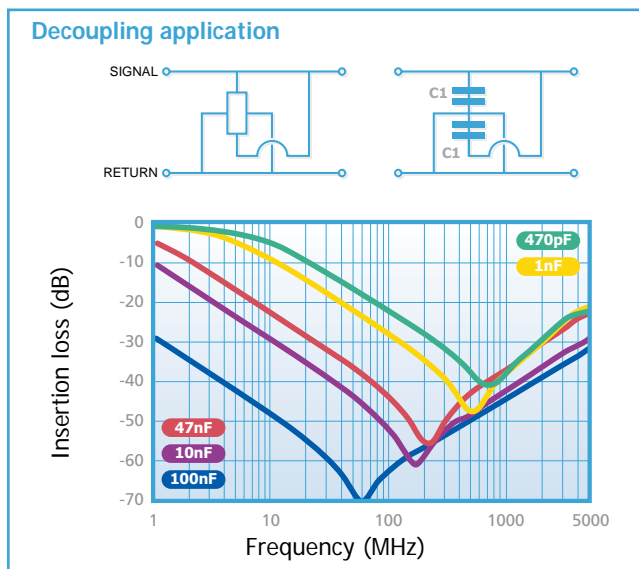
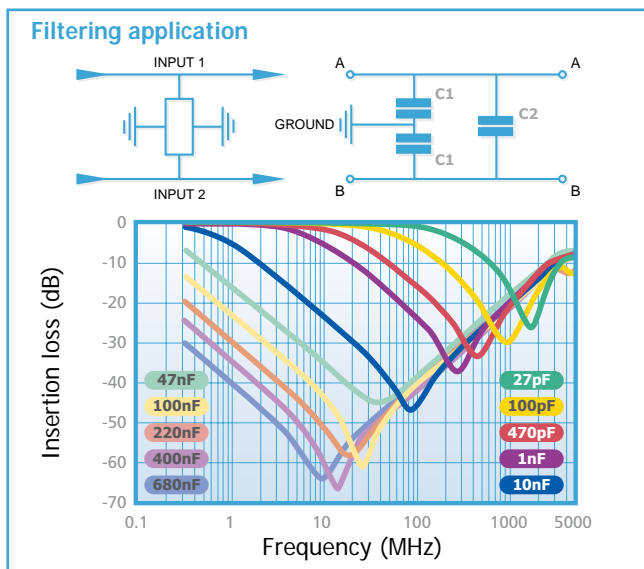

Ordering Information - X2Y IPC range

1812	Y	100	0334	M	X	T	E03
Chip Size	Termination	Voltage	Capacitance in picofarads (pF) C ₁	Tolerance	Dielectric	Packaging	Type
0805 1206 1410 1812	J = Nickel Barrier (Tin) *Y = FlexiCap™ (Tin - X7R only) A = (Tin/Lead) Not RoHS compliant. *H = FlexiCap™ (Tin/Lead) Not RoHS compliant.	025 = 25V 050 = 50V 100 = 100V 200 = 200V 500 = 500V	First digit is 0. Second and third digits are significant figures of capacitance code. The fourth digit is number of zeros following Example: 0334 = 330nF. Note: C ₁ = 2C ₂	M = ±20% (Tighter tolerances may be available on request).	A = COG/NP0 AEC-Q200 C = COG/NP0 E = X7R AEC-Q200 X = X7R	T = 178mm (7") reel R = 330mm (13") reel B = Bulk	Syfer X2Y Integrated Passive Component

Note: *FlexiCap™ termination only available in X7R material. Please contact the sales office for any special requirements.

Reeled quantities

178mm (7") reel	0805	1206	1410	1812
	3000	2500	2000	500

330mm (13") reel	0805	1206	1410	1812
	12000	10000	8000	2000

Packaging information - SM Filters

Tape and reel packing of surface mount EMI filters for automatic placement is in accordance with IEC60286-3.

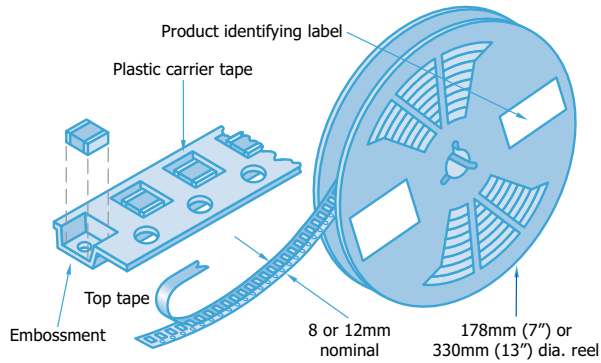

Reel dimensions mm (inches)

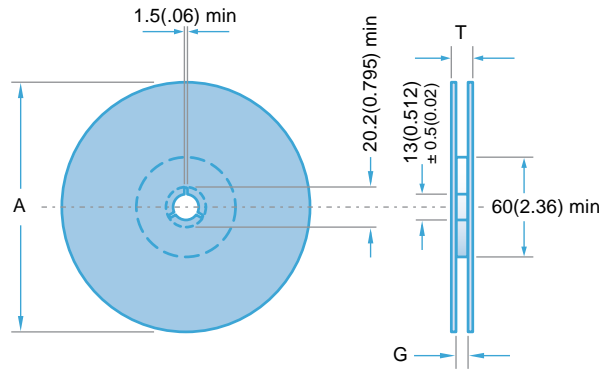

Symbol	Description	178mm reel	330mm reel
A	Reel diameter	178 (7)	330 (13)
G	Reel inside width	8.4 (0.33)	12.4 (0.49)
T	Reel outside width	14.4 (0.56) max	18.4 (0.72) max

Peel force

The peel force of the top sealing tape is between 0.2 and 1.0 Newton at 180°. The breaking force of the carrier and sealing tape in the direction of unreeling is greater than 10 Newtons.

Tape dimensions

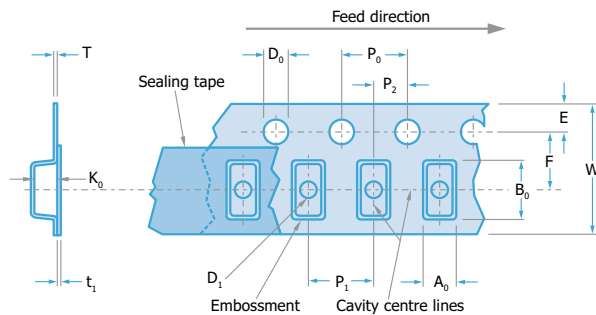

Symbol	Description	Dimensions mm (inches)	
		8mm tape	12mm tape
A ₀	Width of cavity	Dependent on chip size to minimise rotation	
B ₀	Length of cavity		
K ₀	Depth of cavity		
W	Width of tape	8.0 (0.315)	12.0 (0.472)
F	Distance between drive hole centres and cavity centres	3.5 (0.138)	5.5 (0.213)
E	Distance between drive hole centres and tape edge	1.75 (0.069)	
P ₁	Distance between cavity centres	4.0 (0.156)	8.0 (0.315)
P ₂	Axial distance between drive hole centres and cavity centres	2.0 (0.079)	
P ₀	Axial distance between drive hole centres	4.0 (0.156)	
D ₀	Drive hole diameter	1.5 (0.059)	
D ₁	Diameter of cavity piercing	1.0 (0.039)	1.5 (0.059)
XT	Carrier tape thickness	0.3 (0.012) ± 0.1 (0.004)	0.4 (0.016) ± 0.1 (0.004)
Xt ₁	Top tape thickness	0.1 (0.004) max	

Packaging information - SM Filters

Missing components

The number of missing components in the tape may not exceed 0.25% of the total quantity with not more than three consecutive components missing. This must be followed by at least six properly placed components.

Identification

Each reel is labelled with the following information: manufacturer, product code, capacitance, tolerance, rated voltage, dielectric type, batch number, date code and quantity of components.

Leader and Trailer

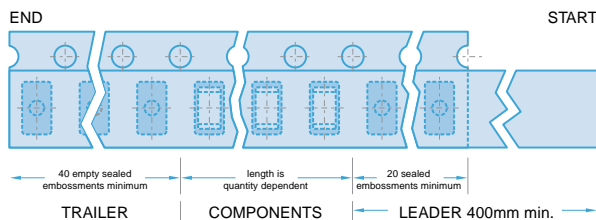

Component orientation

Tape and reeling is in accordance with IEC 60286 part 3, which defines the packaging specifications of leadless components on continuous tapes.

Notes: 1) IEC60286-3 states $A_0 < B_0$
(see Tape dimensions on page 44).

Outer Packaging

Outer carton dimensions mm (inches) max.

Reel Size	No. of reels	L	W	T
178 (7.0)	1	185 (7.28)	185 (7.28)	25 (0.98)
178 (7.0)	4	190 (7.48)	195 (7.76)	75 (2.95)
330 (13.0)	1	335 (13.19)	335 (13.19)	25 (0.98)

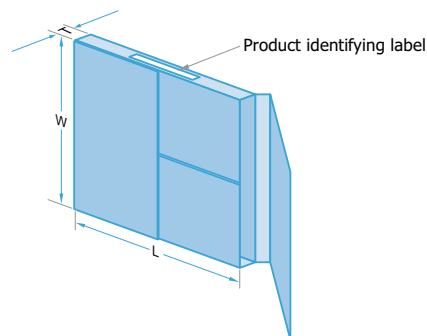

Note: Labelling of box and reel with bar codes (Code 39) available by arrangement.

Reel quantities

Chip size		0805	1206	1806	1812	SBSG	SBSM	SBSP
Max. chip thickness		1.0mm	1.1mm	1.1mm	2.1mm	2.5mm	3.18mm	1.6mm
		0.05"	0.06"	0.06"	0.1"	0.1"	0.125"	0.063"
Reel quantities	178mm (7")	3000	2500	2500	500	500	500	1500
	330mm (13")	12000	10000	10000	2000	2000	2000	6000

Bulk packing - tubs

Chips are supplied in rigid re-sealable plastic tubs together with impact cushioning wadding. Tubs are labelled with the details: chip size, capacitance, tolerance, rated voltage, dielectric type, batch number, date code and quantity of components.

Dimensions mm (inches)

H	60 (2.36)
D	50 (1.97)

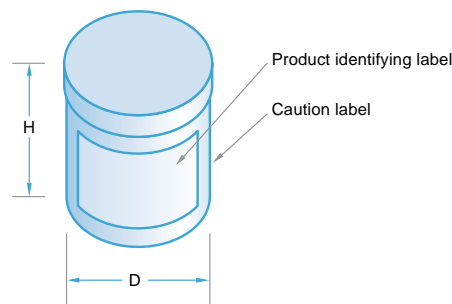

Introduction to Panel Mount EMI Filters

Panel Mount filters are designed to be mounted into a wall or bulkhead that is forming a Faraday cage. The body of the filter acts as the ground connection and the lead pin carries the signal through the filter. All Syfer Panel Mount filters are true feedthrough devices incorporating discoidal capacitors for the maximum performance over the widest frequency range. Performance plots to 15GHz can be supplied on demand.

The Syfer range of filters have the following advantages

- Robust construction
- Feedthrough designs (no chip or leaded 2 terminal capacitors)
- High Voltage / High capacitance
- Stable X7R and Ultra-Stable COG/NPO dielectrics
- Circuit types include 'C', 'L-C', 'T' and 'Pi' as catalogue standards
- Multi-element configurations (e.g. L-C-L-C-L circuits) are also available as custom designs

The Panel Mount range can be categorised into three distinct families:

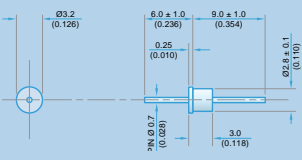
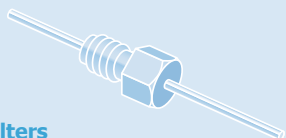

Family	Part numbers	Description
 <p>Disc-on-pin filters</p>	SFSSC*	The lowest cost option. Discoidal feedthrough capacitor mounted on a feedthrough pin. Designed to be solder mounted into panel. Exposed ceramic means care must be taken in handling and operating conditions.
 <p>Solder-in body filters</p>	SFSRC SFSTC SFSUC	As above but with the added benefit of the capacitor being protected by a machined brass body and resin seal. Easier to use and offers greater protection to the ceramic component.
 <p>Threaded ceramic based filters</p>	All other SF**	Single or multi element filters mounted in threaded bodies and resin sealed. Most can be supplied with appropriate mounting hardware. A very wide range of options to suit most mechanical requirements.

All parts can be offered with additional Hi-Rel testing (for example burn-in). Please refer to factory.

Resin Sealed Filters

Construction

The resin sealed panel mount filter ranges feature silver plated brass bodies and copper alloy pins. In all cases the capacitive element is a low ESR high performance discoidal ceramic multilayer device. Tin/lead metalwork plating is available as an option and tin can be considered but is not recommended due to the potential for tin whiskers. Non-standard finishes may incur additional charges or minimum order quantities. Where applicable, sealing is by high purity glob top encapsulant, heat cured.

Inductors

Inductors are ferrite beads. These may suffer from saturation under full operating conditions.

Voltage and Current rating

All voltage and current ratings are quoted over the full operating temperature range -55°C to +125°C. Allowance should be made for anticipated surge currents. Any voltage spike withstand requirements should be referred to the factory as they can have a serious effect on the reliability of the device.

Filters with a dual dc/ac voltage rating are identified in the individual datasheets. Other filters may also be suitable for use under ac voltage conditions, please refer enquiries to the factory. In all cases where a filter is operated under ac conditions, current flow to ground through the capacitor and self-heating of the device will occur, dependent on the capacitance, frequency and voltage. It is the responsibility of the customer to determine if operation in application is acceptable.

Safety

Care should be taken not to exceed the maximum rated voltage and current for the filter.

All the filters in this catalogue are designed to operate at high currents/high voltages and may be fitted with high capacitances resulting in a potential electric shock hazard. Electrical energy may be stored for some time after switch off – do not handle filters without first discharging and/or checking that the stored voltage is at a low level.

Introduction to Panel Mount EMI Filters

Insertion Loss figures

Insertion loss plots and figures supplied are typical only and are measured on in small cavity closed chambers to allow measurements to 10GHz for most styles.

Individual performance plots can be supplied on request. All feedthrough filters display a resonance at some point in the insertion loss sweep and this will be evident in any supplied plot - the

frequency and magnitude of these resonances varies with the design of the test chamber being used. All typical figures tabulated on the datasheets ignore these resonances. If a direct comparison test between components is required, we are happy to carry this out. All measurements are taken using a Vector Network Analyser in a 50Ω system, no load.

Example curves

Panel Mount 'C' Filter Insertion Loss

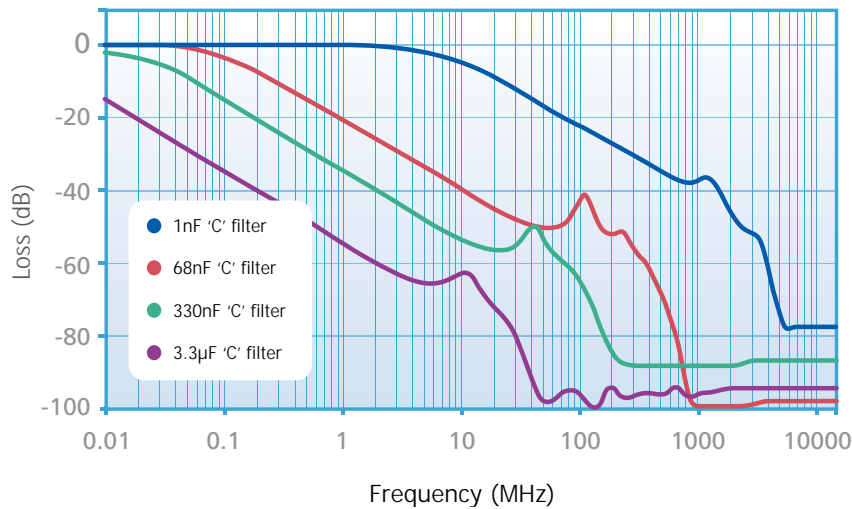

Panel Mount 'Pi' Filter Insertion Loss

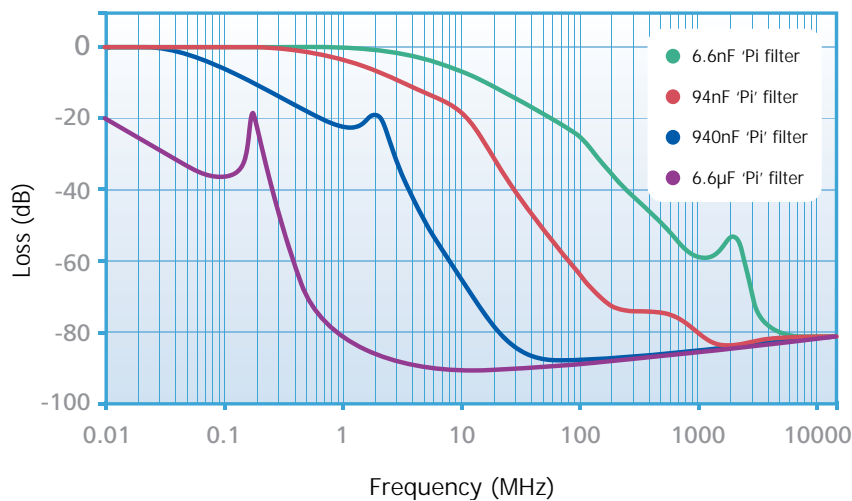

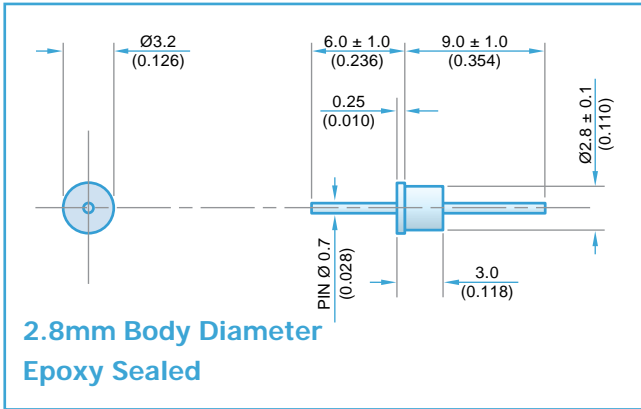
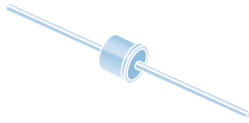

Electrical Details

Electrical Configuration	C Filter	
Capacitance Measurement	@ 1000hr Point	
Current Rating	10A	
Insulation Resistance (IR)	10GΩ or 1000ΩF	
Temperature Rating	-55°C to +125°C	
Ferrite Inductance (Typical)	Not Applicable	

Mechanical Details

Body Flange Diameter	3.2mm (0.126")
Mounting Hole Diameter	3.0mm (0.118")
Max Soldering Temperature	250°C
Temperature Rise	Less than 4°C per second
Soldering Time	10 seconds maximum
Solder Type	Sn62/SAC or equivalent
Weight (Typical)	0.4g (0.015oz)
Finish	Silver plate on copper undercoat

Product Code	Capacitance (-20 +80%)	Dielectric	Rated Voltage (Vdc)	DWV (Vdc)	Typical No-Load Insertion Loss (dB)							
					0.01MHz	0.1MHz	1MHz	10MHz	100MHz	1GHz		
*SFSRC5000100ZC0	10pF	COG/NPO	500#	750	-	-	-	-	-	4		
SFSRC5000220ZC0	22pF				-	-	-	-	-	10		
SFSRC5000470ZC0	47pF				-	-	-	-	1	15		
*SFSRC5000101ZC0	100pF				-	-	-	-	4	22		
SFSRC5000221ZC0	220pF				-	-	-	-	10	29		
SFSRC5000471ZX0	470pF				X7R	200	500	-	-	1	16	35
*SFSRC5000102ZX0	1.0nF							-	-	4	23	41
SFSRC5000222ZX0	2.2nF							-	-	10	30	50
*SFSRC5000472ZX0	4.7nF							-	-	16	36	55
*SFSRC2000103ZX0	10nF							100	250	-	-	4
*SFSRC1000223ZX0	22nF	50	125	-				-	10	29	46	65
*SFSRC0500473ZX0	47nF	-	1	16				35	50	70		

Also rated for operation at 115Vac 400Hz. Self heating will occur - evaluation in situ recommended.
 * Recommended values.

Ordering Information - SFSRC range

SF	S	R	C	500	0472	Z	X	O
Type	Case style	Dia.	Electrical configuration	Voltage (dc)	Capacitance in picofarads (pF)	Tolerance	Dielectric	Nuts & Washers
Syfer Filter	Solder	2.8mm	C = C Filter	050 = 50V 100 = 100V 200 = 200V 500 = 500V	First digit is 0. Second and third digits are significant figures of capacitance code. The fourth digit is number of zeros following Example: 0101 = 100pF 0332 = 3300pF	Z = -20+80%	C = COG/NPO X = X7R	O = Without

Note: The addition of a 4-digit numerical suffix code can be used to denote changes to the standard part. Options include for example: change of finish / alternative voltage rating / non-standard intermediate capacitance values / test requirements. Please refer specific requests to the factory.

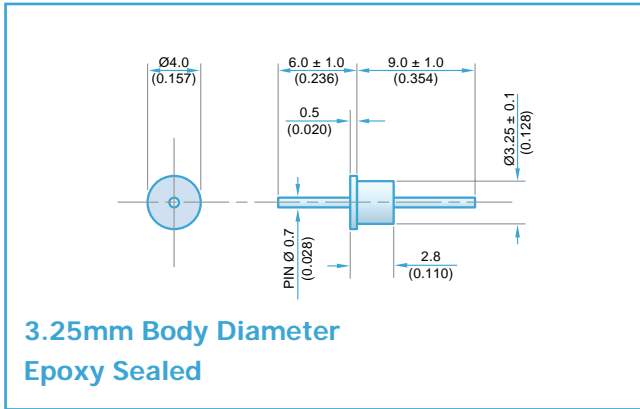
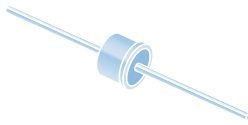

Electrical Details

Electrical Configuration	C Filter
Capacitance Measurement	@ 1000hr Point
Current Rating	10A
Insulation Resistance (IR)	10GΩ or 1000ΩF
Temperature Rating	-55°C to +125°C
Ferrite Inductance (Typical)	Not Applicable

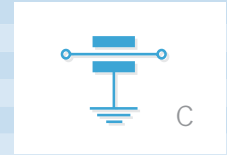

Mechanical Details

Body Flange Diameter	4.0mm (0.157")
Mounting Hole Diameter	3.5mm (0.138")
Max Soldering Temperature	250°C
Temperature Rise	Less than 4°C per second
Soldering Time	10 seconds maximum
Solder Type	Sn62/SAC or equivalent
Weight (Typical)	0.4g (0.015oz)
Finish	Silver plate on copper undercoat

Product Code	Capacitance (±20%) UOS	Dielectric	Rated Voltage (Vdc)	DWV (Vdc)	Typical No-Load Insertion Loss (dB)								
					0.01MHz	0.1MHz	1MHz	10MHz	100MHz	1GHz			
SFSTC5000100ZCO	10pF -20% / +80%	COG/NPO	500#	750	-	-	-	-	-	4			
SFSTC5000150ZCO	15pF -20% / +80%				-	-	-	-	-	7			
SFSTC5000220ZCO	22pF -20% / +80%				-	-	-	-	-	10			
SFSTC5000330ZCO	33pF -20% / +80%				-	-	-	-	-	12			
SFSTC5000470ZCO	47pF -20% / +80%				-	-	-	-	1	15			
SFSTC5000680MCO	68pF				-	-	-	-	2	18			
*SFSTC5000101MCO	100pF				-	-	-	-	4	22			
SFSTC5000151MCO	150pF				-	-	-	-	7	25			
SFSTC5000221MCO	220pF				-	-	-	-	10	29			
SFSTC5000331MCO	330pF				-	-	-	-	13	33			
SFSTC5000471MCO	470pF				-	-	-	1	16	35			
SFSTC5000681MCO	680pF				-	-	-	2	19	39			
SFSTC5000102MX0	1.0nF				X7R	300	600	-	-	-	4	23	41
*SFSTC5000152MX0	1.5nF							-	-	-	7	26	45
*SFSTC5000222MX0	2.2nF							-	-	-	10	30	50
*SFSTC5000332MX0	3.3nF	-	-	-				13	33	52			
*SFSTC5000472MX0	4.7nF	-	-	1				16	36	55			
SFSTC5000682MX0	6.8nF	-	-	2				19	39	57			
*SFSTC5000103MX0	10nF	-	-	4				22	41	60			
SFSTC5000153MX0	15nF	-	-	7				25	44	62			
*SFSTC5000223MX0	22nF	-	-	10				29	46	65			
*SFSTC3000333MX0	33nF	-	-	13				33	48	68			
SFSTC2000473MX0	47nF	-	200	500				-	1	16	35	50	70
SFSTC1000683MX0	68nF	-	100	250				-	2	19	39	54	>70
SFSTC0500104MX0	100nF	-	50	125				-	4	22	41	57	>70

Also rated for operation at 115Vac 400Hz. Self heating will occur - evaluation in situ recommended.
* Recommended values.

Ordering Information - SFSTC range

SF	S	T	C	500	0223	M	X	O
Type	Case style	Dia.	Electrical configuration	Voltage (dc)	Capacitance in picofarads (pF)	Tolerance	Dielectric	Nuts & Washers
Syfer Filter	Solder	3.25mm	C = C Filter	050 = 50V 100 = 100V 200 = 200V 300 = 300V 500 = 500V	First digit is 0. Second and third digits are significant figures of capacitance code. The fourth digit is number of zeros following Example: 0101 = 100pF 0332 = 3300pF	M = ±20% Z = -20+80%	C = COG/NPO X = X7R	O = Without

Note: The addition of a 4-digit numerical suffix code can be used to denote changes to the standard part. Options include for example: change of finish / alternative voltage rating / non-standard intermediate capacitance values / test requirements. Please refer specific requests to the factory.

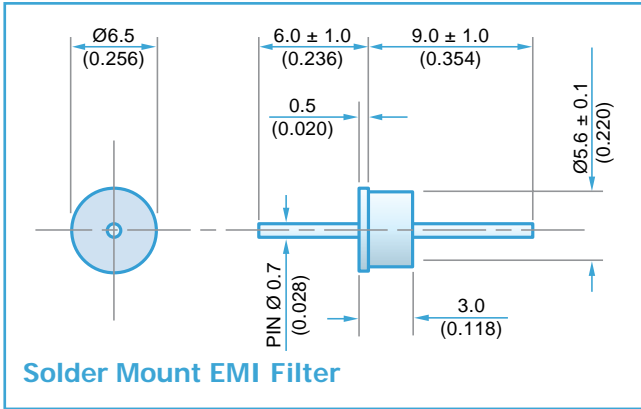
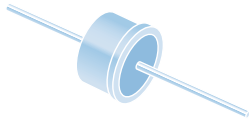

Electrical Details

Electrical Configuration	C Filter	
Capacitance Measurement	@ 1000hr Point	
Current Rating	10A	
Insulation Resistance (IR)	10GΩ or 1000ΩF	
Temperature Rating	-55°C to +125°C	
Ferrite Inductance (Typical)	Not Applicable	

Mechanical Details

Body Flange Diameter	6.5mm (0.256")
Mounting Hole Diameter	5.8mm (0.228")
Max. Soldering Temperature	250°C
Temperature Rise	Less than 4°C per second
Soldering Time	10 seconds maximum
Solder Type	Sn62/SAC or equivalent
Weight (Typical)	0.7g (0.025oz)
Finish	Silver plate on copper undercoat

Product Code	Capacitance (±20%) UOS	Dielectric	Rated Voltage (Vdc)	DWV (Vdc)	Typical No-Load Insertion Loss (dB)								
					0.01MHz	0.1MHz	1MHz	10MHz	100MHz	1GHz			
*SFSUC5000100ZC0	10pF -20% / +80%	COG/NPO	500#	750	-	-	-	-	-	4			
SFSUC5000150ZC0	15pF -20% / +80%				-	-	-	-	-	7			
SFSUC5000220ZC0	22pF -20% / +80%				-	-	-	-	-	10			
SFSUC5000330ZC0	33pF -20% / +80%				-	-	-	-	-	12			
*SFSUC5000470ZC0	47pF -20% / +80%				-	-	-	-	1	15			
*SFSUC5000680MC0	68pF				-	-	-	-	2	18			
*SFSUC5000101MC0	100pF				-	-	-	-	4	22			
SFSUC5000151MC0	150pF				-	-	-	-	7	25			
*SFSUC5000221MC0	220pF				-	-	-	-	10	29			
*SFSUC5000331MC0	330pF				-	-	-	-	13	33			
*SFSUC5000471MC0	470pF				-	-	-	1	16	35			
SFSUC5000681MC0	680pF				-	-	-	2	19	36			
*SFSUC5000102MX0	1.0nF				X7R	200	500	-	-	-	4	23	41
SFSUC5000152MX0	1.5nF							-	-	-	7	26	45
*SFSUC5000222MX0	2.2nF							-	-	-	10	30	50
SFSUC5000332MX0	3.3nF	-	-	-				13	33	52			
*SFSUC5000472MX0	4.7nF	-	-	1				16	36	55			
SFSUC5000682MX0	6.8nF	-	-	2				19	39	57			
*SFSUC5000103MX0	10nF	-	-	4				22	41	60			
*SFSUC5000153MX0	15nF	-	-	7				25	44	62			
*SFSUC5000223MX0	22nF	-	-	10				29	46	65			
SFSUC5000333MX0	33nF	-	-	13				33	48	68			
*SFSUC5000473MX0	47nF	-	1	16				35	50	70			
*SFSUC5000683MX0	68nF	-	2	19				39	54	>70			
*SFSUC5000104MX0	100nF	-	4	22				41	57	>70			
SFSUC5000154MX0	150nF	-	7	25				45	60	>70			
*SFSUC2000224MX0	220nF		100	250				-	10	29	49	62	>70
SFSUC1000334MX0	330nF		100	100	-	13	33	52	66	>70			
*SFSUC1000474MX0	470nF		50	125	1	16	35	55	68	>70			
SFSUC0500684MX0	680nF				2	19	38	58	70	>70			

Also rated for operation at 115Vac 400Hz. Self heating will occur - evaluation in situ recommended. * Recommended values.

Ordering Information - SFSUC range

SF	S	U	C	500	0154	M	X	O
Type	Case style	Dia.	Electrical configuration	Voltage (dc)	Capacitance in picofarads (pF)	Tolerance	Dielectric	Nuts & Washers
Syfer Filter	Solder	5.6mm	C = C Filter	050 = 50V 100 = 100V 200 = 200V 500 = 500V	First digit is 0. Second and third digits are significant figures of capacitance code. The fourth digit is number of zeros following Example: 0101 = 100pF 0332 = 3300pF	M = ±20% Z = -20+80%	C = COG/NPO X = X7R	O = Without

Note: The addition of a 4-digit numerical suffix code can be used to denote changes to the standard part. Options include for example: change of finish / alternative voltage rating / non-standard intermediate capacitance values / test requirements. Please refer specific requests to the factory.

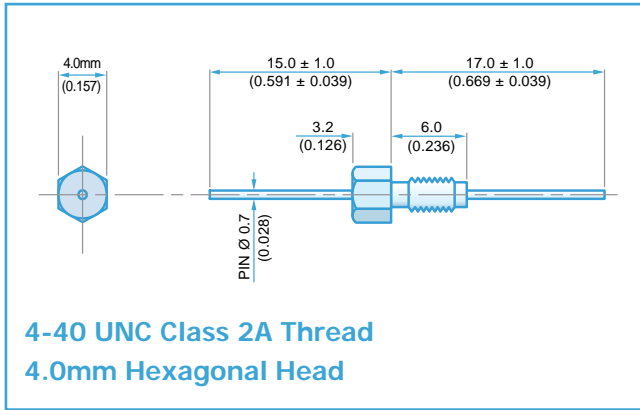
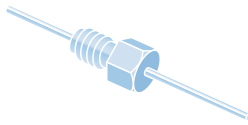

Electrical Details

Electrical Configuration	C Filter
Capacitance Measurement	@ 1000hr Point
Current Rating	10A
Insulation Resistance (IR)	10GΩ or 1000ΩF
Temperature Rating	-55°C to +125°C
Ferrite Inductance (Typical)	Not Applicable

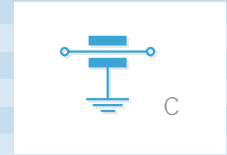

Mechanical Details

Head (A/F)	4mm (0.157")
Nut A/F	Not Applicable
Washer diameter	Not Applicable
Mounting Torque	Not Applicable
Mounting Hole Diameter	4-40 UNC Class 2B tapped hole
Max. Panel Thickness	Not Applicable
Weight (Typical)	0.5g (0.017oz)
Finish	Silver plate on copper undercoat

Product Code	Capacitance (±20%) UOS	Dielectric	Rated Voltage (Vdc)	DWV (Vdc)	Typical No-Load Insertion Loss (dB)					
					0.01MHz	0.1MHz	1MHz	10MHz	100MHz	1GHz
*SFAAC5000100ZC	10pF -20% / +80%	COG/NPO	500#	750	-	-	-	-	-	4
SFAAC5000150ZC	15pF -20% / +80%				-	-	-	-	-	7
SFAAC5000220ZC	22pF -20% / +80%				-	-	-	-	-	10
SFAAC5000330ZC	33pF -20% / +80%				-	-	-	-	-	12
*SFAAC5000470ZC	47pF -20% / +80%				-	-	-	-	1	15
*SFAAC5000680MC	68pF				-	-	-	-	2	18
*SFAAC5000101MC	100pF				-	-	-	-	4	22
SFAAC5000151MC	150pF				-	-	-	-	7	25
*SFAAC5000221MC	220pF				-	-	-	-	10	29
*SFAAC5000331MC	330pF				-	-	-	-	13	33
*SFAAC5000471MX	470pF	1X7R	500#	750	-	-	-	1	16	35
SFAAC5000681MX	680pF				-	-	-	2	19	36
*SFAAC5000102MX	1.0nF	X7R	200	500	-	-	-	4	23	41
SFAAC5000152MX	1.5nF				-	-	-	7	26	45
*SFAAC5000222MX	2.2nF				-	-	-	10	30	50
SFAAC5000332MX	3.3nF				-	-	-	13	33	52
*SFAAC5000472MX	4.7nF				-	-	1	16	36	55
*SFAAC5000682MX	6.8nF				-	-	2	19	39	57
*SFAAC5000103MX	10nF				-	-	4	22	41	60
*SFAAC5000153MX	15nF				-	-	7	25	44	62
*SFAAC5000223MX	22nF				-	-	10	29	46	65
SFAAC5000333MX	33nF				-	-	13	33	48	68
*SFAAC2000473MX	47nF	500	100	250	-	1	16	35	50	70
SFAAC2000683MX	68nF				-	2	19	39	54	>70
*SFAAC1000104MX	100nF				-	4	22	41	57	>70
*SFAAC0500154MX	150nF	500	50	125	-	7	25	45	60	>70

Also rated for operation at 115Vac 400Hz. Self heating will occur - evaluation in situ recommended. * Recommended values. † Also available in COG/NPO.

Ordering Information - SFAAC range

SF	A	A	C	500	0333	M	X	O
Type	Case style	Thread	Electrical configuration	Voltage (dc)	Capacitance in picofarads (pF)	Tolerance	Dielectric	Hardware
Syfer Filter	4.0mm Hex Head	4-40 UNC	C = C Filter	050 = 50V 100 = 100V 200 = 200V 500 = 500V	First digit is 0. Second and third digits are significant figures of capacitance code. The fourth digit is number of zeros following Example: 0101 = 100pF 0332 = 3300pF	M = ±20% Z = -20+80%	C = COG/NPO X = X7R	O = Without

Note: The addition of a 4-digit numerical suffix code can be used to denote changes to the standard part. Options include for example: change of finish / alternative voltage rating / non-standard intermediate capacitance values / test requirements. Please refer specific requests to the factory.

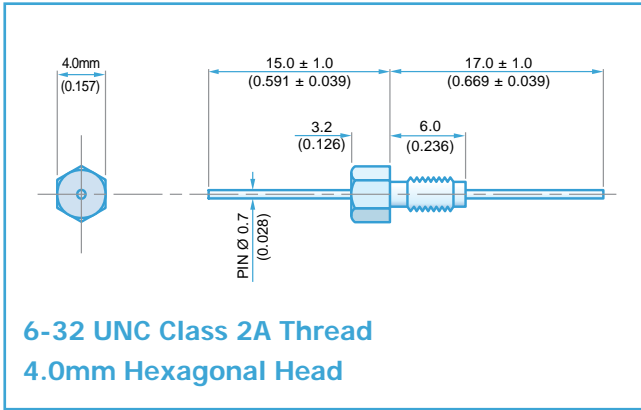
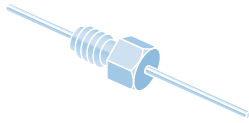

Electrical Details

Electrical Configuration	C Filter	
Capacitance Measurement	@ 1000hr Point	
Current Rating	10A	
Insulation Resistance (IR)	10GΩ or 1000ΩF	
Temperature Rating	-55°C to +125°C	
Ferrite Inductance (Typical)	Not Applicable	

Mechanical Details

Head (A/F)	4mm (0.157")
Nut A/F	4.75mm (0.187")
Washer diameter	6.9mm (0.272")
Mounting Torque	0.3Nm (2.65lbf in) max. if using nut 0.15Nm (1.32lbf in) max. into tapped hole
Mounting Hole Diameter	3.7mm ±0.1 (0.146" ±0.004")
Max. Panel Thickness	3.2mm (0.126")
Weight (Typical)	0.6g (0.02oz)
Finish	Silver plate on copper undercoat

Product Code	Capacitance (±20%) UOS	Dielectric	Rated Voltage (Vdc)	DWV (Vdc)	Typical No-Load Insertion Loss (dB)					
					0.01MHz	0.1MHz	1MHz	10MHz	100MHz	1GHz
*SFABC5000100ZC	10pF -20% / +80%	COG/NPO	500#	750	-	-	-	-	-	4
SFABC5000150ZC	15pF -20% / +80%				-	-	-	-	-	7
SFABC5000220ZC	22pF -20% / +80%				-	-	-	-	-	10
SFABC5000330ZC	33pF -20% / +80%				-	-	-	-	-	12
*SFABC5000470ZC	47pF -20% / +80%				-	-	-	-	1	15
*SFABC5000680MC	68pF				-	-	-	-	2	18
*SFABC5000101MC	100pF				-	-	-	-	4	22
SFABC5000151MC	150pF				-	-	-	-	7	25
*SFABC5000221MC	220pF				-	-	-	-	10	29
*SFABC5000331MC	330pF				-	-	-	-	13	33
*SFABC5000471MX	470pF	†X7R	500#	750	-	-	-	1	16	35
SFABC5000681MX	680pF	-			-	-	2	19	36	
*SFABC5000102MX	1.0nF	X7R			-	-	-	4	23	41
SFABC5000152MX	1.5nF				-	-	-	7	26	45
*SFABC5000222MX	2.2nF				-	-	-	10	30	50
SFABC5000332MX	3.3nF				-	-	-	13	33	52
*SFABC5000472MX	4.7nF				-	-	1	16	36	55
SFABC5000682MX	6.8nF				-	-	2	19	39	57
*SFABC5000103MX	10nF				-	-	4	22	41	60
*SFABC5000153MX	15nF				-	-	7	25	44	62
*SFABC5000223MX	22nF		-	-	10	29	46	65		
SFABC5000333MX	33nF		-	-	13	33	48	68		
*SFABC2000473MX	47nF		200	500	-	1	16	35	50	70
SFABC2000683MX	68nF		-	2	19	39	54	>70		
*SFABC2000104MX	100nF		100	250	-	4	22	41	57	>70
*SFABC0500154MX	150nF		50	125	-	7	25	45	60	>70

Also rated for operation at 115Vac 400Hz. Self heating will occur - evaluation in situ recommended. * Recommended values. † Also available in COG/NPO.

Ordering Information - SFABC range

SF	A	B	C	500	0102	M	X	O
Type	Case style	Thread	Electrical configuration	Voltage (dc)	Capacitance in picofarads (pF)	Tolerance	Dielectric	Hardware
Syfer Filter	4.0mm Hex Head	6-32 UNC	C = C Filter	050 = 50V 100 = 100V 200 = 200V 500 = 500V	First digit is 0. Second and third digits are significant figures of capacitance code. The fourth digit is number of zeros following Example: 0101 = 100pF 0332 = 3300pF	M = ±20% Z = -20+80%	C = COG/NPO X = X7R	O = Without 1 = With

Note: The addition of a 4-digit numerical suffix code can be used to denote changes to the standard part. Options include for example: change of finish / alternative voltage rating / non-standard intermediate capacitance values / test requirements. Please refer specific requests to the factory.

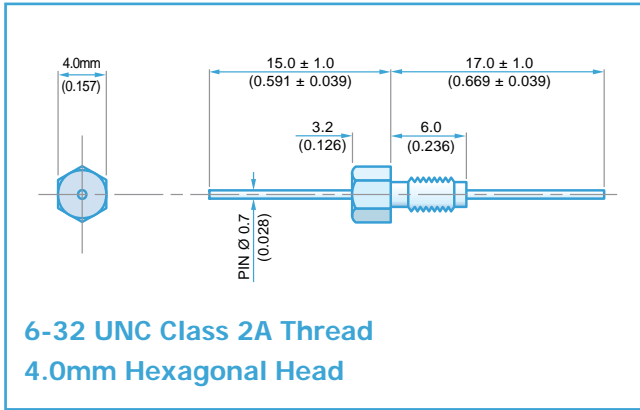
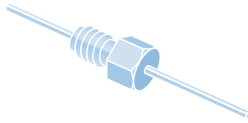

Electrical Details	
Electrical Configuration	L-C Filter
Capacitance Measurement	@ 1000hr Point
Current Rating	10A
Insulation Resistance (IR)	10GΩ or 1000ΩF
Temperature Rating	-55°C to +125°C
Ferrite Inductance (Typical)	50nH

Mechanical Details	
Head (A/F)	4.0mm (0.157")
Nut A/F	4.75mm (0.187")
Washer diameter	6.9mm (0.272")
Mounting Torque	0.3Nm (2.65lbf in) max. if using nut 0.15Nm (1.32lbf in) max. into tapped hole
Mounting Hole Diameter	3.7mm ±0.1 (0.146" ±0.004")
Max. Panel Thickness	3.2mm (0.126")
Weight (Typical)	0.6g (0.02oz)
Finish	Silver plate on copper undercoat

Product Code	Capacitance (±20%) UOS	Dielectric	Rated Voltage (Vdc)	DWV (Vdc)	Typical No-Load Insertion Loss (dB)							
					0.01MHz	0.1MHz	1MHz	10MHz	100MHz	1GHz		
*SFABL5000100ZC	10pF -20% / +80%	COG/NPO	500#	750	-	-	-	-	-	6		
SFABL5000150ZC	15pF -20% / +80%				-	-	-	-	-	9		
SFABL5000220ZC	22pF -20% / +80%				-	-	-	-	-	12		
SFABL5000330ZC	33pF -20% / +80%				-	-	-	-	1	15		
*SFABL5000470ZC	47pF -20% / +80%				-	-	-	-	2	19		
*SFABL5000680MC	68pF				-	-	-	-	4	20		
*SFABL5000101MC	100pF				-	-	-	-	7	24		
SFABL5000151MC	150pF				-	-	-	-	10	27		
*SFABL5000221MC	220pF				-	-	-	-	12	30		
*SFABL5000331MC	330pF				-	-	-	1	16	34		
*SFABL5000471MX	470pF	†X7R			200	500	-	-	-	2	19	38
SFABL5000681MX	680pF	-					-	-	3	22	41	
*SFABL5000102MX	1.0nF	X7R					-	-	-	6	25	44
SFABL5000152MX	1.5nF						-	-	-	9	29	48
*SFABL5000222MX	2.2nF						-	-	-	12	31	51
SFABL5000332MX	3.3nF						-	-	-	15	35	54
*SFABL5000472MX	4.7nF						-	-	1	18	39	57
SFABL5000682MX	6.8nF						-	-	2	21	41	60
*SFABL5000103MX	10nF						-	-	4	23	43	63
*SFABL5000153MX	15nF						-	-	7	27	46	66
*SFABL5000223MX	22nF		-	-	10	30	48	68				
SFABL5000333MX	33nF		-	-	13	34	50	70				
*SFABL2000473MX	47nF		100	250	-	1	17	37	51	>70		
SFABL2000683MX	68nF				-	2	20	40	55	>70		
*SFABL1000104MX	100nF		50	125	-	4	22	44	60	>70		
*SFABL0500154MX	150nF				-	7	25	47	62	>70		

Also rated for operation at 115Vac 400Hz. Self heating will occur - evaluation in situ recommended. * Recommended values. † Also available in COG/NPO.

Ordering Information- SFABL range

SF	A	B	L	500	0333	M	X	0
Type	Case style	Thread	Electrical configuration	Voltage (dc)	Capacitance in picofarads (pF)	Tolerance	Dielectric	Hardware
Syfer Filter	4.0mm Hex Head	6-32 UNC	L = L-C Filter	050 = 50V 100 = 100V 200 = 200V 500 = 500V	First digit is 0. Second and third digits are significant figures of capacitance code. The fourth digit is number of zeros following Example: 0101 = 100pF 0332 = 3300pF	M = ±20% Z = -20+80%	C = COG/NPO X = X7R	0 = Without 1 = With

Note: The addition of a 4-digit numerical suffix code can be used to denote changes to the standard part. Options include for example: change of finish / alternative voltage rating / non-standard intermediate capacitance values / test requirements. Please refer specific requests to the factory.

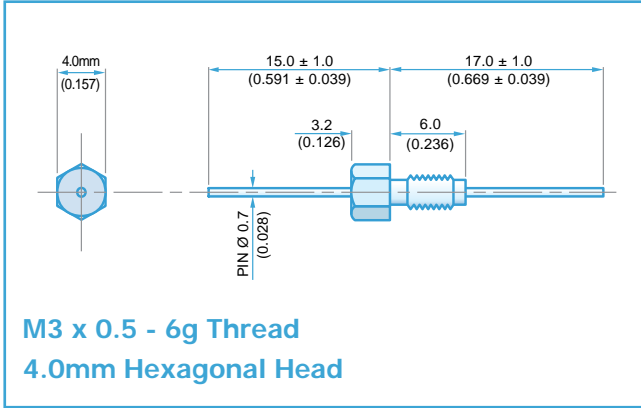
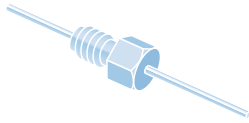

Electrical Details

Electrical Configuration	C Filter	
Capacitance Measurement	@ 1000hr Point	
Current Rating	10A	
Insulation Resistance (IR)	10GΩ or 1000ΩF	
Temperature Rating	-55°C to +125°C	
Ferrite Inductance (Typical)	Not Applicable	

Mechanical Details

Head (A/F)	4.0mm (0.157")
Nut A/F	4.0mm (0.187")
Washer diameter	6.9mm (0.272")
Mounting Torque	0.25Nm (2.21lbf in) max. if using nut 0.15Nm (1.32lbf in) max. into tapped hole
Mounting Hole Diameter	3.15mm ± 0.1 (0.124" ± 0.004")
Max. Panel Thickness	3.2mm (0.126")
Weight (Typical)	0.5g (0.017oz)
Finish	Silver plate on copper undercoat

Product Code	Capacitance (±20%) UOS	Dielectric	Rated Voltage (Vdc)	DWV (Vdc)	Typical No-Load Insertion Loss (dB)					
					0.01MHz	0.1MHz	1MHz	10MHz	100MHz	1GHz
*SFAJC5000100ZC	10pF -20% / +80%	COG/NPO	500#	750	-	-	-	-	-	4
SFAJC5000150ZC	15pF -20% / +80%				-	-	-	-	-	7
SFAJC5000220ZC	22pF -20% / +80%				-	-	-	-	-	10
SFAJC5000330ZC	33pF -20% / +80%				-	-	-	-	-	12
*SFAJC5000470ZC	47pF -20% / +80%				-	-	-	-	1	15
*SFAJC5000680MC	68pF				-	-	-	-	2	18
*SFAJC5000101MC	100pF				-	-	-	-	4	22
SFAJC5000151MC	150pF				-	-	-	-	7	25
*SFAJC5000221MC	220pF				-	-	-	-	10	29
*SFAJC5000331MC	330pF				-	-	-	-	13	33
*SFAJC5000471MX	470pF	†X7R	500#	750	-	-	-	1	16	35
SFAJC5000681MX	680pF	-			-	-	2	19	36	
*SFAJC5000102MX	1.0nF	X7R			-	-	-	4	23	41
SFAJC5000152MX	1.5nF				-	-	-	7	26	45
*SFAJC5000222MX	2.2nF				-	-	-	10	30	50
SFAJC5000332MX	3.3nF				-	-	-	13	33	52
*SFAJC5000472MX	4.7nF				-	-	1	16	36	55
*SFAJC5000682MX	6.8nF				-	-	2	19	39	57
*SFAJC5000103MX	10nF				-	-	4	22	41	60
*SFAJC5000153MX	15nF				-	-	7	25	44	62
*SFAJC5000223MX	22nF		-	-	10	29	46	65		
SFAJC5000333MX	33nF		-	-	13	33	48	68		
*SFAJC2000473MX	47nF	X7R	200	500	-	1	16	35	50	70
SFAJC2000683MX	68nF		-	2	19	39	54	>70		
*SFAJC1000104MX	100nF		100	250	-	4	22	41	57	>70
*SFAJC0500154MX	150nF		50	125	-	7	25	45	60	>70

Also rated for operation at 115Vac 400Hz. Self heating will occur - evaluation in situ recommended. * Recommended values. † Also available in COG/NPO.

Ordering Information - SFAJC range

SF	A	J	C	050	0154	M	X	O
Type	Case style	Thread	Electrical configuration	Voltage (dc)	Capacitance in picofarads (pF)	Tolerance	Dielectric	Hardware
Syfer Filter	4.0mm Hex Head	M3	C = C Filter	050 = 50V 100 = 100V 200 = 200V 500 = 500V	First digit is 0. Second and third digits are significant figures of capacitance code. The fourth digit is number of zeros following Example: 0101 = 100pF 0332 = 3300pF	M = ±20% Z = -20+80%	C = COG/NPO X = X7R	O = Without 1 = With

Note: The addition of a 4-digit numerical suffix code can be used to denote changes to the standard part. Options include for example: change of finish / alternative voltage rating / non-standard intermediate capacitance values / test requirements. Please refer specific requests to the factory.

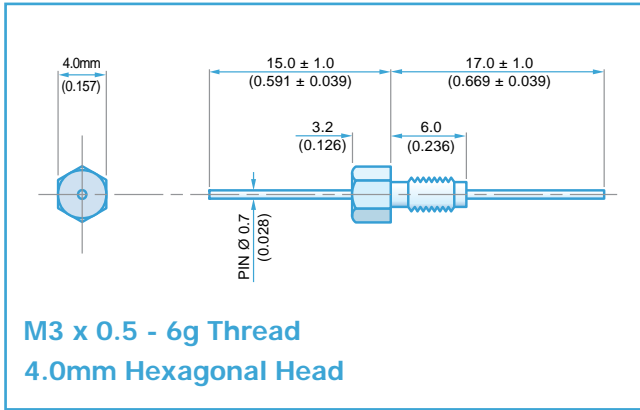
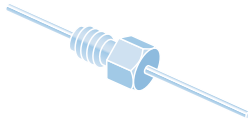

Electrical Details

Electrical Configuration	L-C Filter
Capacitance Measurement	@ 1000hr Point
Current Rating	10A
Insulation Resistance (IR)	10GΩ or 1000ΩF
Temperature Rating	-55°C to +125°C
Ferrite Inductance (Typical)	50nH

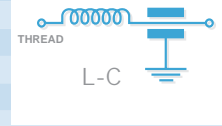

Mechanical Details

Head (A/F)	4.0mm (0.157")
Nut A/F	4.0mm (0.157")
Washer diameter	6.9mm (0.272")
Mounting Torque	0.25Nm (2.21lbf in) max. if using nut 0.15Nm (1.32lbf in) max. into tapped hole
Mounting Hole Diameter	3.15mm ±0.1 (0.124" ±0.004")
Max. Panel Thickness	3.2mm (0.126")
Weight (Typical)	0.5g (0.017oz)
Finish	Silver plate on copper undercoat

Product Code	Capacitance (±20%) UOS	Dielectric	Rated Voltage (Vdc)	DWV (Vdc)	Typical No-Load Insertion Loss (dB)													
					0.01MHz	0.1MHz	1MHz	10MHz	100MHz	1GHz								
*SFAJL5000100ZC	10pF -20% / +80%	COG/NPO	500#	750	-	-	-	-	-	6								
SFAJL5000150ZC	15pF -20% / +80%				-	-	-	-	-	9								
SFAJL5000220ZC	22pF -20% / +80%				-	-	-	-	-	12								
SFAJL5000330ZC	33pF -20% / +80%				-	-	-	-	1	15								
*SFAJL5000470ZC	47pF -20% / +80%				-	-	-	-	2	19								
*SFAJL5000680MC	68pF				-	-	-	-	4	20								
*SFAJL5000101MC	100pF				-	-	-	-	7	24								
SFAJL5000151MC	150pF				-	-	-	-	10	27								
*SFAJL5000221MC	220pF				-	-	-	-	12	30								
*SFAJL5000331MC	330pF				-	-	-	1	16	34								
*SFAJL5000471MX	470pF				1X7R	200	500	-	-	-	2	19	38					
SFAJL5000681MX	680pF							-	-	-	3	22	41					
*SFAJL5000102MX	1.0nF	X7R			100			250	-	-	-	6	25	44				
SFAJL5000152MX	1.5nF								-	-	-	9	29	48				
*SFAJL5000222MX	2.2nF								-	-	-	12	31	51				
SFAJL5000332MX	3.3nF								-	-	-	15	35	54				
*SFAJL5000472MX	4.7nF								-	-	1	18	39	57				
SFAJL5000682MX	6.8nF								-	-	2	21	41	60				
*SFAJL5000103MX	10nF								-	-	4	23	43	63				
*SFAJL5000153MX	15nF								-	-	7	27	46	66				
*SFAJL5000223MX	22nF								-	-	10	30	48	68				
SFAJL5000333MX	33nF								-	-	13	34	50	70				
*SFAJL2000473MX	47nF								200	50	125	-	1	17	37	51	>70	
SFAJL2000683MX	68nF											-	2	20	40	55	>70	
*SFAJL1000104MX	100nF	100	100	250					-			4	22	44	60	>70		
*SFAJL0500154MX	150nF								50			50	125	-	7	25	47	62

Also rated for operation at 115Vac 400Hz. Self heating will occur - evaluation in situ recommended. * Recommended values. † Also available in COG/NPO.

Ordering Information - SFAJL range

SF	A	J	L	200	0683	M	X	1
Type	Case style	Thread	Electrical configuration	Voltage (dc)	Capacitance in picofarads (pF)	Tolerance	Dielectric	Hardware
Syfer Filter	4.0mm Hex Head	M3	L = L-C Filter	050 = 50V 100 = 100V 200 = 200V 500 = 500V	First digit is 0. Second and third digits are significant figures of capacitance code. The fourth digit is number of zeros following Example: 0101 = 100pF 0332 = 3300pF	M = ±20% Z = -20+80%	C = COG/NPO X = X7R	0 = Without 1 = With

Note: The addition of a 4-digit numerical suffix code can be used to denote changes to the standard part. Options include for example: change of finish / alternative voltage rating / non-standard intermediate capacitance values / test requirements. Please refer specific requests to the factory.

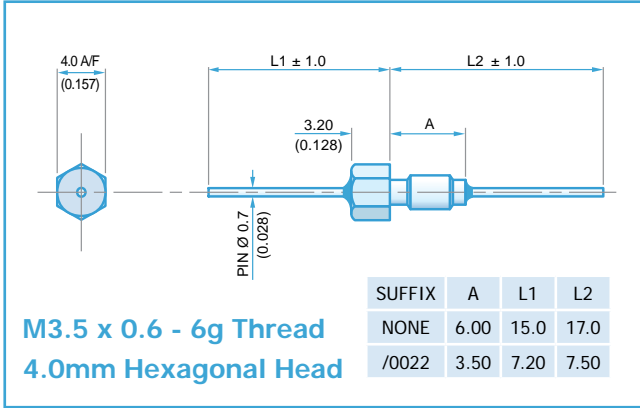
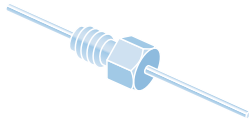

Electrical Details	
Electrical Configuration	C Filter
Capacitance Measurement	@ 1000hr Point
Current Rating	10A
Insulation Resistance (IR)	10GΩ or 1000ΩF
Temperature Rating	-55°C to +125°C
Ferrite Inductance (Typical)	Not Applicable

Mechanical Details	
Head (A/F)	4.0mm (0.157")
Nut A/F	4.75mm (0.187")
Washer diameter	6.9mm (0.272")
Mounting Torque	0.35Nm (3.09lbf in) max. if using nut 0.18Nm (1.59lbf in) max. into tapped hole
Mounting Hole Diameter	3.7mm ±0.1 (0.146" ±0.004")
Max. Panel Thickness	3.25mm (0.128")
Weight (Typical)	0.6g (0.02oz)
Finish	Silver plate on copper undercoat

Product Code	Capacitance (±20%) UOS	Dielectric	Rated Voltage (Vdc)	DWV (Vdc)	Typical No-Load Insertion Loss (dB)							
					0.01MHz	0.1MHz	1MHz	10MHz	100MHz	1GHz		
*SFAKC5000100ZC	10pF -20% / +80%	COG/NPO	500#	750	-	-	-	-	-	4		
SFAKC5000150ZC	15pF -20% / +80%				-	-	-	-	-	7		
SFAKC5000220ZC	22pF -20% / +80%				-	-	-	-	-	10		
SFAKC5000330ZC	33pF -20% / +80%				-	-	-	-	-	12		
*SFAKC5000470ZC	47pF -20% / +80%				-	-	-	-	1	15		
*SFAKC5000680MC	68pF				-	-	-	-	2	18		
*SFAKC5000101MC	100pF				-	-	-	-	4	22		
SFAKC5000151MC	150pF				-	-	-	-	7	25		
*SFAKC5000221MC	220pF				-	-	-	-	10	29		
*SFAKC5000331MC	330pF				-	-	-	-	13	33		
*SFAKC5000471MX	470pF	†X7R			200	500	-	-	-	1	16	35
SFAKC5000681MX	680pF	-					-	-	2	19	36	
*SFAKC5000102MX	1.0nF	X7R					-	-	-	4	23	41
SFAKC5000152MX	1.5nF						-	-	-	7	26	45
*SFAKC5000222MX	2.2nF						-	-	-	10	30	50
SFAKC5000332MX	3.3nF						-	-	-	13	33	52
*SFAKC5000472MX	4.7nF						-	-	1	16	36	55
*SFAKC5000682MX	6.8nF						-	-	2	19	39	57
*SFAKC5000103MX	10nF						-	-	4	22	41	60
*SFAKC5000153MX	15nF						-	-	7	25	44	62
*SFAKC5000223MX	22nF		-	-	10	29	46	65				
SFAKC5000333MX	33nF		-	-	13	33	48	68				
*SFAKC2000473MX	47nF	/0022	100	250	-	1	16	35	50	70		
SFAKC2000683MX	68nF		200	500	-	2	19	39	54	>70		
*SFAKC1000104MX	100nF	/0022	50	125	-	4	22	41	57	>70		
*SFAKC0500154MX	150nF		100	250	-	7	25	45	60	>70		

Also rated for operation at 115Vac 400Hz. Self heating will occur - evaluation in situ recommended. * Recommended values. † Also available in COG/NPO.

Ordering Information - SFAKC range

SF	A	K	C	500	0680	M	C	0	/0022
Type	Case style	Thread	Electrical configuration	Voltage (dc)	Capacitance in picofarads (pF)	Tolerance	Dielectric	Hardware	Suffix
Syfer Filter	4.0mm Hex Head	M3.5	C = C Filter	050 = 50V 100 = 100V 200 = 200V 500 = 500V	First digit is 0. Second and third digits are significant figures of capacitance code. The fourth digit is number of zeros following Example: 0101 = 100pF 0332 = 3300pF	M = ±20% Z = -20+80%	C = COG/NPO X = X7R	0 = Without 1 = With	/0022 = short thread & lead length (see drawing)

Note: The addition of a 4-digit numerical suffix code can be used to denote changes to the standard part. Options include for example: change of finish / alternative voltage rating / non-standard intermediate capacitance values / test requirements. Please refer specific requests to the factory.

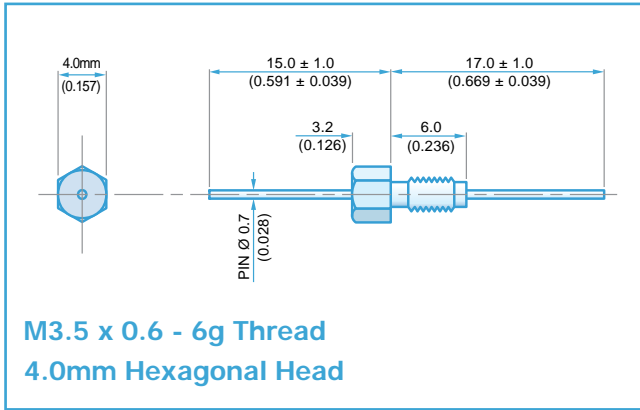
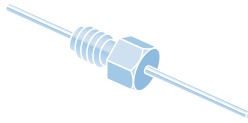

Electrical Details

Electrical Configuration	L-C Filter
Capacitance Measurement	@ 1000hr Point
Current Rating	10A
Insulation Resistance (IR)	10GΩ or 1000ΩF
Temperature Rating	-55°C to +125°C
Ferrite Inductance (Typical)	50nH

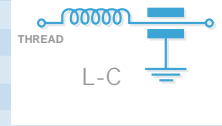

Mechanical Details

Head (A/F)	4.0mm (0.157")
Nut A/F	4.75mm (0.187")
Washer diameter	6.9mm (0.272")
Mounting Torque	0.35Nm (3.09lbf in) max. if using nut 0.18Nm (1.59lbf in) max. into tapped hole
Mounting Hole Diameter	3.7mm ±0.1 (0.146" ±0.004")
Max. Panel Thickness	3.25mm (0.128")
Weight (Typical)	0.6g (0.02oz)
Finish	Silver plate on copper undercoat

Product Code	Capacitance (±20%) UOS	Dielectric	Rated Voltage (Vdc)	DWV (Vdc)	Typical No-Load Insertion Loss (dB)					
					0.01MHz	0.1MHz	1MHz	10MHz	100MHz	1GHz
*SFAKL5000100ZC	10pF -20% / +80%	COG/NPO	500#	750	-	-	-	-	-	6
SFAKL5000150ZC	15pF -20% / +80%				-	-	-	-	-	9
SFAKL5000220ZC	22pF -20% / +80%				-	-	-	-	-	12
SFAKL5000330ZC	33pF -20% / +80%				-	-	-	-	1	15
*SFAKL5000470ZC	47pF -20% / +80%				-	-	-	-	2	19
*SFAKL5000680MC	68pF				-	-	-	-	4	20
*SFAKL5000101MC	100pF				-	-	-	-	7	24
SFAKL5000151MC	150pF				-	-	-	-	10	27
*SFAKL5000221MC	220pF				-	-	-	-	12	30
*SFAKL5000331MC	330pF				-	-	-	1	16	34
*SFAKL5000471MX	470pF	†X7R	500#	750	-	-	-	2	19	38
SFAKL5000681MX	680pF				-	-	-	3	22	41
*SFAKL5000102MX	1.0nF	X7R	200	500	-	-	-	6	25	44
SFAKL5000152MX	1.5nF				-	-	-	9	29	48
*SFAKL5000222MX	2.2nF				-	-	-	12	31	51
SFAKL5000332MX	3.3nF				-	-	-	15	35	54
*SFAKL5000472MX	4.7nF				-	-	1	18	39	57
SFAKL5000682MX	6.8nF				-	-	2	21	41	60
*SFAKL5000103MX	10nF				-	-	4	23	43	63
*SFAKL5000153MX	15nF				-	-	7	27	46	66
*SFAKL5000223MX	22nF				-	-	10	30	48	68
SFAKL5000333MX	33nF				-	-	13	34	50	70
*SFAKL2000473MX	47nF	-	100	250	-	4	22	44	60	>70
SFAKL2000683MX	68nF	-	50	125	-	7	25	47	62	>70
SFAKL1000104MX	100nF	-	-	-	-	4	22	44	60	>70
SFAKL0500154MX	150nF	-	-	-	-	7	25	47	62	>70

Also rated for operation at 115Vac 400Hz. Self heating will occur - evaluation in situ recommended. * Recommended values. † Also available in COG/NPO.

Ordering Information - SFAKL range

SF	A	K	L	100	0104	M	X	1
Type	Case style	Thread	Electrical configuration	Voltage (dc)	Capacitance in picofarads (pF)	Tolerance	Dielectric	Hardware
Syfer Filter	4.0mm Hex Head	M3.5	L = L-C Filter	050 = 50V 100 = 100V 200 = 200V 500 = 500V	First digit is 0. Second and third digits are significant figures of capacitance code. The fourth digit is number of zeros following Example: 0101 = 100pF 0332 = 3300pF	M = ±20% Z = -20+80%	C = COG/NPO X = X7R	0 = Without 1 = With

Note: The addition of a 4-digit numerical suffix code can be used to denote changes to the standard part. Options include for example: change of finish / alternative voltage rating / non-standard intermediate capacitance values / test requirements. Please refer specific requests to the factory.

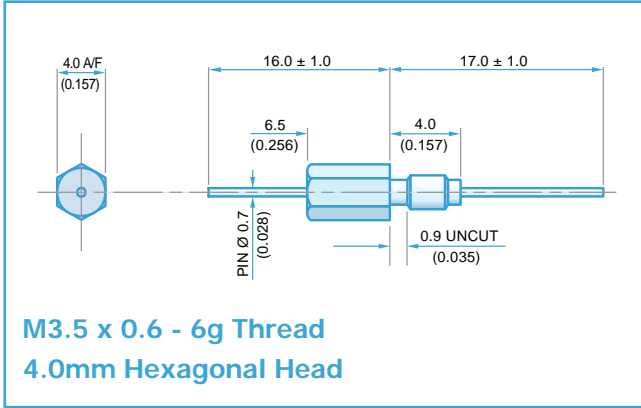
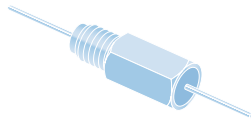

Electrical Details

Electrical Configuration	T Filter
Capacitance Measurement	@ 1000hr Point
Current Rating	10A
Insulation Resistance (IR)	10GΩ or 1000ΩF
Temperature Rating	-55°C to +125°C
Ferrite Inductance (Typical)	100nH

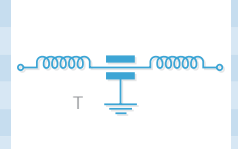

Mechanical Details

Head (A/F)	4.0mm (0.157")
Nut A/F	4.75mm (0.187")
Washer diameter	6.9mm (0.272")
Mounting Torque	0.35Nm (3.09lbf in) max. If using nut 0.18Nm (1.59lbf in) max. into tapped hole
Mounting Hole Diameter	3.7mm ±0.1 (0.146" ±0.004")
Max. Panel Thickness	3.25mm (0.128")
Weight (Typical)	0.6g (0.02oz)
Finish	Silver plate on copper undercoat

Product Code	Capacitance (±20%) UOS	Dielectric	Rated Voltage (Vdc)	DWV (Vdc)	Typical No-Load Insertion Loss (dB)					
					0.01MHz	0.1MHz	1MHz	10MHz	100MHz	1GHz
*SFAKT5000100ZC	10pF -20% / +80%	COG/NPO	500#	750	-	-	-	-	-	9
SFAKT5000150ZC	15pF -20% / +80%				-	-	-	-	-	11
SFAKT5000220ZC	22pF -20% / +80%				-	-	-	-	1	14
SFAKT5000330ZC	33pF -20% / +80%				-	-	-	-	2	18
*SFAKT5000470ZC	47pF -20% / +80%				-	-	-	-	4	20
*SFAKT5000680MC	68pF				-	-	-	-	6	23
*SFAKT5000101MC	100pF				-	-	-	-	9	27
SFAKT5000151MC	150pF				-	-	-	-	12	30
*SFAKT5000221MC	220pF				-	-	-	-	15	33
*SFAKT5000331MC	330pF				-	-	-	1	19	36
*SFAKT5000471MX	470pF	†X7R	500#	750	-	-	-	2	21	40
SFAKT5000681MX	680pF	-			-	-	4	24	43	
*SFAKT5000102MX	1.0nF	X7R			-	-	-	7	28	47
SFAKT5000152MX	1.5nF				-	-	-	10	30	50
*SFAKT5000222MX	2.2nF				-	-	-	13	34	53
SFAKT5000332MX	3.3nF				-	-	-	17	38	57
*SFAKT5000472MX	4.7nF				-	-	-	19	40	59
SFAKT5000682MX	6.8nF				-	-	1	23	43	63
*SFAKT5000103MX	10nF				-	-	4	26	45	66
*SFAKT5000153MX	15nF				-	-	7	29	47	68
*SFAKT5000223MX	22nF		-	-	10	33	49	70		
SFAKT5000333MX	33nF		-	-	14	36	50	>70		
*SFAKT2000473MX	47nF		200	500	-	1	17	39	52	>70
SFAKT2000683MX	68nF		-	-	-	2	20	42	57	>70
*SFAKT1000104MX	100nF		100	250	-	4	22	46	62	>70
*SFAKT0500154MX	150nF		50	125	-	7	25	49	68	>70

Also rated for operation at 115Vac 400Hz. Self heating will occur - evaluation in situ recommended. * Recommended values. † Also available in COG/NPO.

Ordering Information - SFAKT range

SF	A	K	T	500	0102	M	X	O
Type	Case style	Thread	Electrical configuration	Voltage (dc)	Capacitance in picofarads (pF)	Tolerance	Dielectric	Hardware
Syfer Filter	4.0mm Hex Head	M3.5	T = T Filter	050 = 50V 100 = 100V 200 = 200V 500 = 500V	First digit is 0. Second and third digits are significant figures of capacitance code. The fourth digit is number of zeros following Example: 0101 = 100pF 0332 = 3300pF	M = ±20% Z = -20+80%	C = COG/NPO X = X7R	0 = Without 1 = With

Note: The addition of a 4-digit numerical suffix code can be used to denote changes to the standard part. Options include for example: change of finish / alternative voltage rating / non-standard intermediate capacitance values / test requirements. Please refer specific requests to the factory.

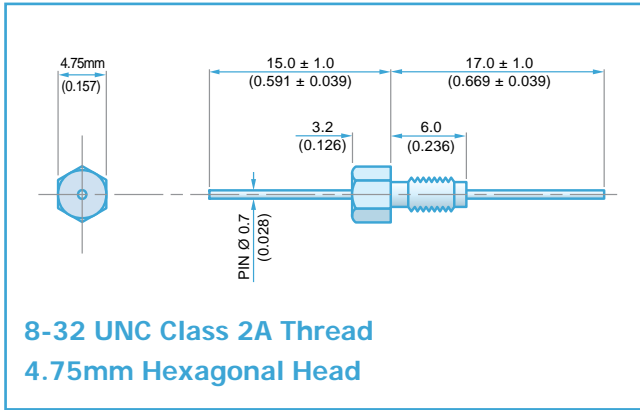
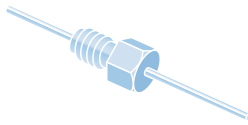

Electrical Details

Electrical Configuration	C Filter
Capacitance Measurement	@ 1000hr Point
Current Rating	10A
Insulation Resistance (IR)	10GΩ or 1000ΩF
Temperature Rating	-55°C to +125°C
Ferrite Inductance (Typical)	Not Applicable



Mechanical Details

Head (A/F)	4.75mm (0.187")
Nut A/F	6.35mm (0.250")
Washer diameter	8mm (0.315")
Mounting Torque	0.5Nm (4.42lbf in) max. if using nut 0.25Nm (2.21lbf in) max. into tapped hole
Mounting Hole Diameter	4.4mm ±0.1 (0.173" ±0.004")
Max. Panel Thickness	2.9mm (0.114")
Weight (Typical)	1.2g (0.04oz)
Finish	Silver plate on copper undercoat

Product Code	Capacitance (±20%) UOS	Dielectric	Rated Voltage (Vdc)	DWV (Vdc)	Typical No-Load Insertion Loss (dB)					
					0.01MHz	0.1MHz	1MHz	10MHz	100MHz	1GHz
*SFBC5000100ZC	10pF -20% / +80%	COG/NPO	500#	750	-	-	-	-	-	4
SFBC5000150ZC	15pF -20% / +80%				-	-	-	-	-	7
SFBC5000220ZC	22pF -20% / +80%				-	-	-	-	-	10
SFBC5000330ZC	33pF -20% / +80%				-	-	-	-	-	12
*SFBC5000470ZC	47pF -20% / +80%				-	-	-	-	1	15
*SFBC5000680MC	68pF				-	-	-	-	2	18
*SFBC5000101MC	100pF				-	-	-	-	4	22
SFBC5000151MC	150pF				-	-	-	-	7	25
*SFBC5000221MC	220pF				-	-	-	-	10	29
*SFBC5000331MC	330pF				-	-	-	-	13	33
*SFBC5000471MX	470pF	1X7R	500#	750	-	-	-	1	16	35
SFBC5000681MX	680pF				-	-	-	2	19	36
*SFBC5000102MX	1.0nF	X7R	500#	750	-	-	-	4	23	41
SFBC5000152MX	1.5nF				-	-	-	7	26	45
*SFBC5000222MX	2.2nF				-	-	-	10	30	50
SFBC5000332MX	3.3nF				-	-	-	13	33	52
*SFBC5000472MX	4.7nF				-	-	1	16	36	55
SFBC5000682MX	6.8nF				-	-	2	19	39	57
*SFBC5000103MX	10nF				-	-	4	22	41	60
*SFBC5000153MX	15nF				-	-	7	25	44	62
*SFBC5000223MX	22nF				-	-	10	29	46	65
SFBC5000333MX	33nF				-	-	13	33	48	68
*SFBC2000473MX	47nF	X7R	200	500	-	1	16	35	50	70
SFBC2000683MX	68nF		-	2	19	39	54	>70		
*SFBC1000104MX	100nF		100	250	-	4	22	41	57	>70
*SFBC0500154MX	150nF	50	125	-	7	25	45	60	>70	

Also rated for operation at 115Vac 400Hz. Self heating will occur - evaluation in situ recommended. * Recommended values. † Also available in COG/NPO.

Ordering Information - SFBC range

SF	B	C	C	500	0102	M	X	O
Type	Case style	Thread	Electrical configuration	Voltage (dc)	Capacitance in picofarads (pF)	Tolerance	Dielectric	Hardware
Syfer Filter	4.75mm Hex Head	8-32 UNC	C = C Filter	050 = 50V 100 = 100V 200 = 200V 500 = 500V	First digit is 0. Second and third digits are significant figures of capacitance code. The fourth digit is number of zeros following Example: 0101 = 100pF 0332 = 3300pF	M = ±20% Z = -20+80%	C = COG/NPO X = X7R	0 = Without 1 = With

Note: The addition of a 4-digit numerical suffix code can be used to denote changes to the standard part. Options include for example: change of finish / alternative voltage rating / non-standard intermediate capacitance values / test requirements. Please refer specific requests to the factory.

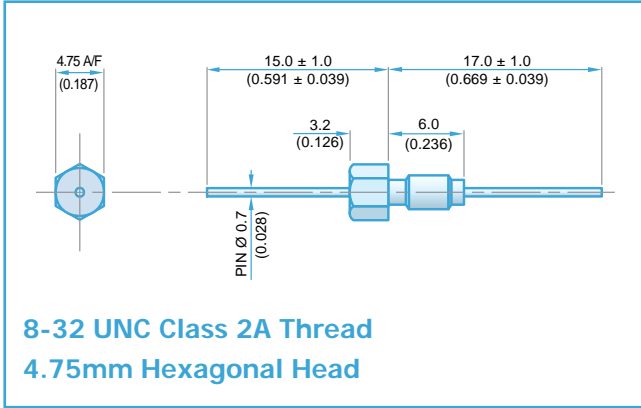
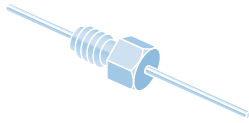

Electrical Details

Electrical Configuration	L-C Filter
Capacitance Measurement	@ 1000hr Point
Current Rating	10A
Insulation Resistance (IR)	10GΩ or 1000ΩF
Temperature Rating	-55°C to +125°C
Ferrite Inductance (Typical)	50nH

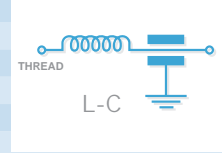

Mechanical Details

Head (A/F)	4.75mm (0.187")
Nut A/F	6.35mm (0.250")
Washer diameter	8mm (0.315")
Mounting Torque	0.5Nm (4.42lbf in) max. if using nut 0.25Nm (2.21lbf in) max. into tapped hole
Mounting Hole Diameter	4.4mm ±0.1 (0.173" ±0.004")
Max. Panel Thickness	2.9mm (0.114")
Weight (Typical)	1.2g (0.04oz)
Finish	Silver plate on copper undercoat

Product Code	Capacitance (±20%) UOS	Dielectric	Rated Voltage (Vdc)	DWV (Vdc)	Typical No-Load Insertion Loss (dB)								
					0.01MHz	0.1MHz	1MHz	10MHz	100MHz	1GHz			
*SFBCL5000100ZC	10pF -20% / +80%	COG/NPO	500#	750	-	-	-	-	-	6			
SFBCL5000150ZC	15pF -20% / +80%				-	-	-	-	-	9			
SFBCL5000220ZC	22pF -20% / +80%				-	-	-	-	-	12			
SFBCL5000330ZC	33pF -20% / +80%				-	-	-	-	1	15			
*SFBCL5000470ZC	47pF -20% / +80%				-	-	-	-	2	19			
*SFBCL5000680MC	68pF				-	-	-	-	4	20			
*SFBCL5000101MC	100pF				-	-	-	-	7	24			
SFBCL5000151MC	150pF				-	-	-	-	10	27			
*SFBCL5000221MC	220pF				-	-	-	-	12	30			
*SFBCL5000331MC	330pF				-	-	-	1	16	34			
*SFBCL5000471MX	470pF				†X7R	-	-	-	2	19	38		
SFBCL5000681MX	680pF				-	-	-	-	3	22	41		
*SFBCL5000102MX	1.0nF				X7R	-	-	-	6	25	44		
SFBCL5000152MX	1.5nF					-	-	-	9	29	48		
*SFBCL5000222MX	2.2nF	-				-	-	12	31	51			
SFBCL5000332MX	3.3nF	-				-	-	15	35	54			
*SFBCL5000472MX	4.7nF	-				-	1	18	39	57			
SFBCL5000682MX	6.8nF	-				-	2	21	41	60			
*SFBCL5000103MX	10nF	-				-	4	23	43	63			
*SFBCL5000153MX	15nF	-				-	7	27	46	66			
*SFBCL5000223MX	22nF	-				-	10	30	48	68			
SFBCL5000333MX	33nF	-				-	13	34	50	70			
*SFBCL2000473MX	47nF	-				200	500	-	1	17	37	51	>70
SFBCL2000683MX	68nF	-				-	-	-	2	20	40	55	>70
*SFBCL1000104MX	100nF	-				100	250	-	4	22	44	60	>70
*SFBCL0500154MX	150nF	-				50	125	-	7	25	47	62	>70

Also rated for operation at 115Vac 400Hz. Self heating will occur - evaluation in situ recommended. * Recommended values. † Also available in COG/NPO.

Ordering Information - SFBCL range

SF	B	C	L	500	0102	M	X	O
Type	Case style	Thread	Electrical configuration	Voltage (dc)	Capacitance in picofarads (pF)	Tolerance	Dielectric	Hardware
Syfer Filter	4.75mm Hex Head	8-32 UNC	L = L-C Filter	050 = 50V 100 = 100V 200 = 200V 500 = 500V	First digit is 0. Second and third digits are significant figures of capacitance code. The fourth digit is number of zeros following Example: 0101 = 100pF 0332 = 3300pF	M = ±20% Z = -20+80%	C = COG/NPO X = X7R	O = Without 1 = With

Note: The addition of a 4-digit numerical suffix code can be used to denote changes to the standard part. Options include for example: change of finish / alternative voltage rating / non-standard intermediate capacitance values / test requirements. Please refer specific requests to the factory.

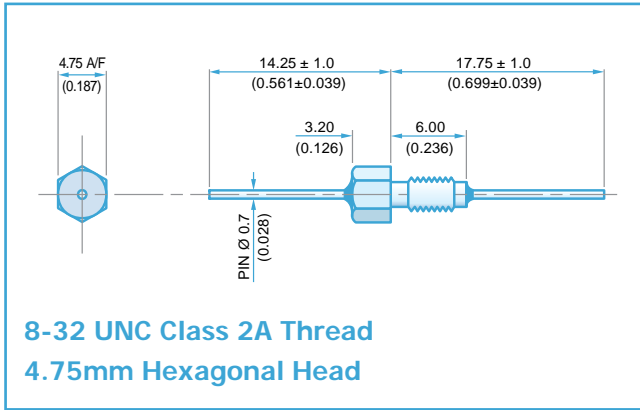

Electrical Details

Electrical Configuration	PI Filter
Capacitance Measurement	@ 1000hr Point
Current Rating	10A
Insulation Resistance (IR)	10GΩ or 1000ΩF
Temperature Rating	-55°C to +125°C
Ferrite Inductance (Typical)	75nH



Mechanical Details

Head (A/F)	4.75mm (0.187")
Nut A/F	6.35mm (0.250")
Washer diameter	9.40mm (0.370")
Mounting Torque	0.5Nm (4.42lbf in) max. if using nut 0.25Nm (2.21lbf in) max. into tapped hole
Mounting Hole Diameter	4.4mm ± 0.1 (0.173" ± 0.004")
Max. Panel Thickness	2.9mm (0.114")
Weight (Typical)	1.2g (0.04oz)
Finish	Silver plate on copper undercoat

Product Code	Capacitance -20/+80%	Dielectric	Rated Voltage (Vdc)	DWV (Vdc)	Typical No-Load Insertion Loss (dB)					
					0.01MHz	0.1MHz	1MHz	10MHz	100MHz	1GHz
*SFBCP5000200ZC	20pF	COG/NPO	500#	750	-	-	-	-	1	11
SFBCP5000440ZC	44pF				-	-	-	-	3	19
SFBCP5000940ZC	94pF				-	-	-	-	6	25
*SFBCP5000201ZC	200pF				-	-	-	-	11	33
SFBCP5000441ZC	440pF				-	-	-	2	18	45
SFBCP5000941ZX	940pF	X7R	200	500	-	-	-	5	25	60
*SFBCP5000202ZX	2nF				-	-	-	10	40	70
SFBCP5000442ZX	4.4nF				-	-	1	17	47	>70
*SFBCP5000942ZX	9.4nF				-	-	4	24	60	>70
*SFBCP2000203ZX	20nF				-	-	9	28	70	>70
*SFBCP1000443ZX	44nF	50	125	250	-	0	14	42	>70	>70
*SFBCP0500943ZX	94nF				-	2	18	57	>70	>70

Also rated for operation at 115Vac 400Hz. Self heating will occur - evaluation in situ recommended. * Recommended values. † Also available in COG/NPO.

Ordering Information - SFBCP range

SF	B	C	P	050	0943	Z	X	0
Type	Case style	Thread	Electrical configuration	Voltage (dc)	Capacitance in picofarads (pF)	Tolerance	Dielectric	Hardware
Syfer Filter	4.75mm Hex Head	8-32 UNC	P = Pi Filter	050 = 50V 100 = 100V 200 = 200V 500 = 500V	First digit is 0. Second and third digits are significant figures of capacitance code. The fourth digit is number of zeros following Example: 0201 = 200pF 0943 = 94000pF	Z = -20+80%	C = COG/NPO X = X7R	0 = Without 1 = With

Note: The addition of a 4-digit numerical suffix code can be used to denote changes to the standard part. Options include for example: change of finish / alternative voltage rating / non-standard intermediate capacitance values / test requirements. Please refer specific requests to the factory.

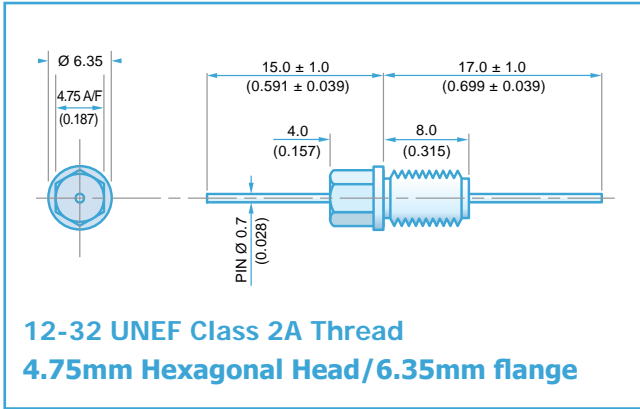
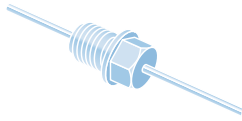

Electrical Details

Electrical Configuration	C Filter	
Capacitance Measurement	@ 1000hr Point	
Current Rating	10A	
Insulation Resistance (IR)	10GΩ or 1000ΩF	
Temperature Rating	-55°C to +125°C	
Ferrite Inductance (Typical)	Not Applicable	

Mechanical Details

Body Flange Diameter	6.35mm (0.250")
Head (A/F)	4.75mm (0.187")
Nut A/F	7.92mm (0.312")
Washer diameter	9.40mm (0.370")
Mounting Torque	0.6Nm (5.31lbf in) max. if using nut 0.3Nm (2.65lbf in) max. into tapped hole
Mounting Hole Diameter	5.7mm ±0.1 (0.224" ±0.004")
Max. Panel Thickness	4.9mm (0.193")
Weight (Typical)	1.5g (0.05oz)
Finish	Silver plate on copper undercoat

Product Code	Capacitance (±20%) UOS	Dielectric	Rated Voltage (Vdc)	DWV (Vdc)	Typical No-Load Insertion Loss (dB)					
					0.01MHz	0.1MHz	1MHz	10MHz	100MHz	1GHz
*SFBC5000100ZC	10pF -20% / +80%	COG/NPO	500#	750	-	-	-	-	-	4
SFBC5000150ZC	15pF -20% / +80%				-	-	-	-	-	7
SFBC5000220ZC	22pF -20% / +80%				-	-	-	-	-	10
SFBC5000330ZC	33pF -20% / +80%				-	-	-	-	-	12
*SFBC5000470ZC	47pF -20% / +80%				-	-	-	-	1	15
*SFBC5000680MC	68pF				-	-	-	-	2	18
*SFBC5000101MC	100pF				-	-	-	-	4	22
SFBC5000151MC	150pF				-	-	-	-	7	25
*SFBC5000221MC	220pF				-	-	-	-	10	29
*SFBC5000331MC	330pF				-	-	-	-	13	33
*SFBC5000471MX	470pF	†X7R	500#	750	-	-	-	1	16	35
SFBC5000681MX	680pF	-			-	-	2	19	36	
*SFBC5000102MX	1.0nF	X7R			-	-	-	4	23	41
SFBC5000152MX	1.5nF				-	-	-	7	26	45
*SFBC5000222MX	2.2nF				-	-	-	10	30	50
SFBC5000332MX	3.3nF				-	-	-	13	33	52
*SFBC5000472MX	4.7nF				-	-	1	16	36	55
SFBC5000682MX	6.8nF				-	-	2	19	39	57
*SFBC5000103MX	10nF				-	-	4	22	41	60
*SFBC5000153MX	15nF				-	-	7	25	44	62
*SFBC5000223MX	22nF		-	-	10	29	46	65		
SFBC5000333MX	33nF		-	-	13	33	48	68		
*SFBC2000473MX	47nF		200	500	-	1	16	35	50	70
SFBC2000683MX	68nF		-	2	19	39	54	>70		
*SFBC1000104MX	100nF		100	250	-	4	22	41	57	>70
*SFBC0500154MX	150nF		50	125	-	7	25	45	60	>70

Also rated for operation at 115Vac 400Hz. Self heating will occur - evaluation in situ recommended. * Recommended values. † Also available in COG/NPO.

Ordering Information - SFBDC range

SF	B	D	C	500	0101	M	C	O
Type	Case style	Thread	Electrical configuration	Voltage (dc)	Capacitance in picofarads (pF)	Tolerance	Dielectric	Hardware
Syfer Filter	4.75mm Hex Head	12-32 UNEF	C = C Filter	050 = 50V 100 = 100V 200 = 200V 500 = 500V	First digit is 0. Second and third digits are significant figures of capacitance code. The fourth digit is number of zeros following Example: 0101 = 100pF 0332 = 3300pF	M = ±20% Z = -20+80%	C = COG/NPO X = X7R	O = Without 1 = With

Note: The addition of a 4-digit numerical suffix code can be used to denote changes to the standard part. Options include for example: change of finish / alternative voltage rating / non-standard intermediate capacitance values / test requirements. Please refer specific requests to the factory.

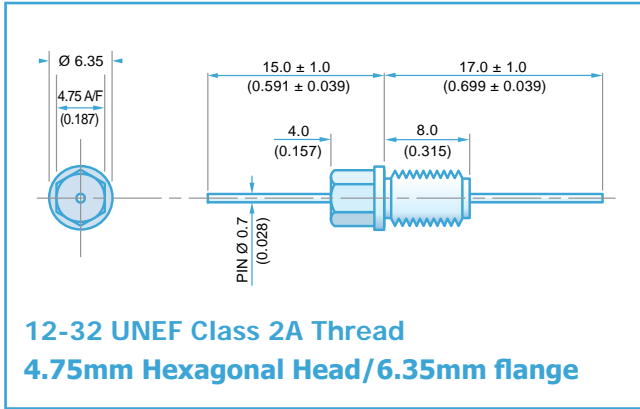
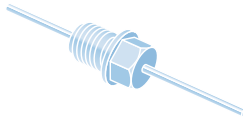

Electrical Details

Electrical Configuration	L-C Filter
Capacitance Measurement	@ 1000hr Point
Current Rating	10A
Insulation Resistance (IR)	10GΩ or 1000ΩF
Temperature Rating	-55°C to +125°C
Ferrite Inductance (Typical)	500nH

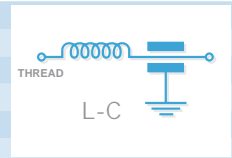

Mechanical Details

Body Flange Diameter	6.35mm (0.250")
Head (A/F)	4.75mm (0.187")
Nut A/F	7.92mm (0.312")
Washer diameter	9.40mm (0.370")
Mounting Torque	0.6Nm (5.31lbf in) max. if using nut 0.3Nm (2.65lbf in) max. into tapped hole
Mounting Hole Diameter	5.7mm ±0.1 (0.224" ±0.004")
Max. Panel Thickness	4.9mm (0.193")
Weight (Typical)	1.5g (0.05oz)
Finish	Silver plate on copper undercoat

Product Code	Capacitance (±20%) UOS	Dielectric	Rated Voltage (Vdc)	DWV (Vdc)	Typical No-Load Insertion Loss (dB)									
					0.01MHz	0.1MHz	1MHz	10MHz	100MHz	1GHz				
*SFBDL5000100ZC	10pF -20% / +80%	COG/NPO	500#	750	-	-	-	-	-	6				
SFBDL5000150ZC	15pF -20% / +80%				-	-	-	-	-	9				
SFBDL5000220ZC	22pF -20% / +80%				-	-	-	-	-	12				
SFBDL5000330ZC	33pF -20% / +80%				-	-	-	-	1	15				
*SFBDL5000470ZC	47pF -20% / +80%				-	-	-	-	2	19				
*SFBDL5000680MC	68pF				-	-	-	-	4	20				
*SFBDL5000101MC	100pF				-	-	-	-	7	24				
SFBDL5000151MC	150pF				-	-	-	-	10	27				
*SFBDL5000221MC	220pF				-	-	-	-	12	30				
*SFBDL5000331MC	330pF				-	-	-	1	16	34				
*SFBDL5000471MX	470pF	1X7R			200	500	-	-	-	2	19	38		
SFBDL5000681MX	680pF						-	-	-	3	22	41		
*SFBDL5000102MX	1.0nF	X7R					100	250	-	-	-	6	25	44
SFBDL5000152MX	1.5nF								-	-	-	9	29	48
*SFBDL5000222MX	2.2nF								-	-	-	12	31	51
SFBDL5000332MX	3.3nF								-	-	-	15	35	54
*SFBDL5000472MX	4.7nF								-	-	1	18	39	57
SFBDL5000682MX	6.8nF								-	-	2	21	41	60
*SFBDL5000103MX	10nF								-	-	4	23	43	63
*SFBDL5000153MX	15nF								-	-	7	27	46	66
*SFBDL5000223MX	22nF								-	-	10	30	48	68
SFBDL5000333MX	33nF								-	-	13	34	50	70
*SFBDL2000473MX	47nF								-	1	17	37	51	>70
SFBDL2000683MX	68nF								-	2	20	40	55	>70
*SFBDL1000104MX	100nF								-	4	22	44	60	>70
*SFBDL0500154MX	150nF								-	7	25	47	62	>70

Also rated for operation at 115Vac 400Hz. Self heating will occur - evaluation in situ recommended. * Recommended values. † Also available in COG/NPO.

Ordering Information - SFBDL range

SF	B	D	L	500	0102	M	X	0
Type	Case style	Thread	Electrical configuration	Voltage (dc)	Capacitance in picofarads (pF)	Tolerance	Dielectric	Hardware
Syfer Filter	4.75mm Hex Head	12-32 UNEF	L = L-C Filter	050 = 50V 100 = 100V 200 = 200V 500 = 500V	First digit is 0. Second and third digits are significant figures of capacitance code. The fourth digit is number of zeros following Example: 0101 = 100pF 0332 = 3300pF	M = ±20% Z = -20+80%	C = COG/NPO X = X7R	0 = Without 1 = With

Note: The addition of a 4-digit numerical suffix code can be used to denote changes to the standard part. Options include for example: change of finish / alternative voltage rating / non-standard intermediate capacitance values / test requirements. Please refer specific requests to the factory.

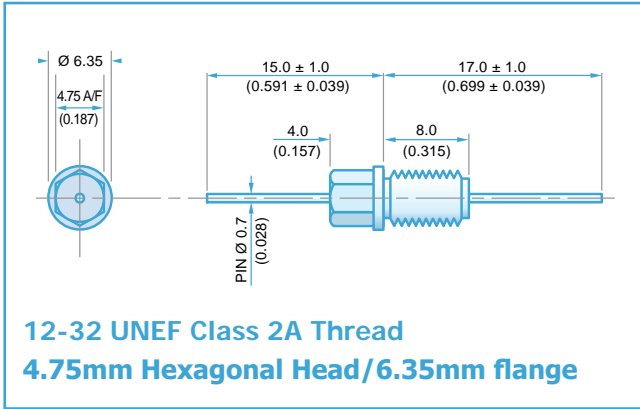
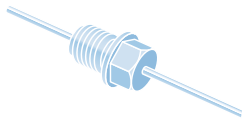

Electrical Details

Electrical Configuration	PI Filter	
Capacitance Measurement	@ 1000hr Point	
Current Rating	10A	
Insulation Resistance (IR)	10GΩ or 1000ΩF	
Temperature Rating	-55°C to +125°C	
Ferrite Inductance (Typical)	250nH	

Mechanical Details

Body Flange Diameter	6.35mm (0.250")
Head (A/F)	4.75mm (0.187")
Nut A/F	7.92mm (0.312")
Washer diameter	9.40mm (0.370")
Mounting Torque	0.6Nm (5.31lbf in) max. if using nut 0.3Nm (2.65lbf in) max. into tapped hole
Mounting Hole Diameter	5.7mm ±0.1 (0.224" ±0.004")
Max. Panel Thickness	4.9mm (0.193")
Weight (Typical)	1.5g (0.05oz)
Finish	Silver plate on copper undercoat

Product Code	Capacitance (±20%) UOS	Dielectric	Rated Voltage (Vdc)	DWV (Vdc)	Typical No-Load Insertion Loss (dB)								
					0.01MHz	0.1MHz	1MHz	10MHz	100MHz	1GHz			
*SFBDP5000200ZC	20pF -20% / +80%	COG/NPO	500#	750	-	-	-	-	1	11			
SFBDP5000300ZC	30pF -20% / +80%				-	-	-	-	2	15			
SFBDP5000440ZC	44pF -20% / +80%				-	-	-	-	3	19			
SFBDP5000660ZC	66pF -20% / +80%				-	-	-	-	4	23			
*SFBDP5000940ZC	94pF -20% / +80%				-	-	-	-	6	29			
*SFBDP500136PMC	136pF				-	-	-	-	8	35			
*SFBDP5000201MC	200pF				-	-	-	-	11	41			
SFBDP5000301MC	300pF				-	-	-	1	15	50			
*SFBDP5000441MC	440pF				-	-	-	2	20	57			
*SFBDP5000661MC	660pF				-	-	-	3	25	65			
*SFBDP5000941MX	940pF				X7R	200	500	-	-	-	5	31	68
SFBDP5001N36MX	1.36nF							-	-	-	7	37	>70
*SFBDP5000202MX	2nF							-	-	-	10	44	>70
SFBDP5000302MX	3nF							-	-	-	13	51	>70
*SFBDP5000442MX	4.4nF							-	-	1	17	59	>70
SFBDP5000662MX	6.6nF							-	-	2	21	64	>70
*SFBDP5000942MX	9.4nF							-	-	4	27	68	>70
SFBDP50013N6MX	13.6nF							-	-	6	34	>70	>70
*SFBDP5000203MX	20nF							-	-	9	40	>70	>70
*SFBDP5000303MX	30nF							-	-	13	48	>70	>70
*SFBDP5000443MX	44nF	-	-	1				54	>70	>70			
SFBDP5000663MX	66nF	-	-	2				63	>70	>70			
*SFBDP2000943MX	94nF	-	200	500				4	18	68	>70	>70	
SFBDP200136NMX	136nF	-	200	500				8	25	>70	>70	>70	
*SFBDP1000204MX	200nF	-	100	250				10	27	>70	>70	>70	
*SFBDP0500304MX	300nF	-	50	125	13	30	>70	>70	>70				

Also rated for operation at 115Vac 400Hz. Self heating will occur - evaluation in situ recommended. * Recommended values. † Also available in COG/NPO.

Ordering Information - SFBDP range

SF	B	D	P	200	0943	M	X	O
Type	Case style	Thread	Electrical configuration	Voltage (dc)	Capacitance in picofarads (pF)	Tolerance	Dielectric	Hardware
Syfer Filter	4.75mm Hex Head	12-32 UNEF	P = Pi Filter	050 = 50V 100 = 100V 200 = 200V 500 = 500V	First digit is 0. Second and third digits are significant figures of capacitance code. The fourth digit is number of zeros following Example: 0201 = 200pF 0943 = 9400pF	M = ±20% Z = -20+80%	C = COG/NPO X = X7R	0 = Without 1 = With

Note: The addition of a 4-digit numerical suffix code can be used to denote changes to the standard part. Options include for example: change of finish / alternative voltage rating / non-standard intermediate capacitance values / test requirements. Please refer specific requests to the factory.

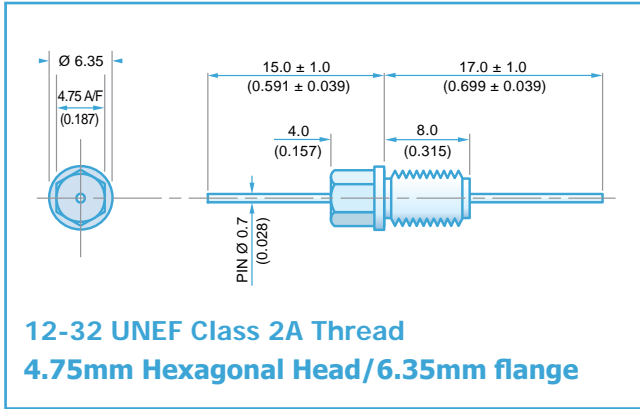
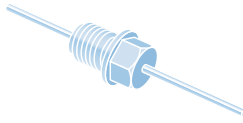

Electrical Details

Electrical Configuration	T Filter
Capacitance Measurement	@ 1000hr Point
Current Rating	10A
Insulation Resistance (IR)	10GΩ or 1000ΩF
Temperature Rating	-55°C to +125°C
Ferrite Inductance (Typical)	450nH

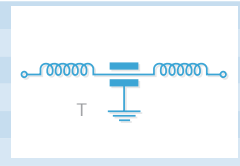

Mechanical Details

Body Flange Diameter	6.35mm (0.250")
Head (A/F)	4.75mm (0.187")
Nut A/F	7.92mm (0.312")
Washer diameter	9.40mm (0.370")
Mounting Torque	0.6Nm (5.31lbf in) max. if using nut 0.3Nm (2.65lbf in) max. into tapped hole
Mounting Hole Diameter	5.7mm ±0.1 (0.224" ±0.004")
Max. Panel Thickness	4.9mm (0.193")
Weight (Typical)	1.5g (0.05oz)
Finish	Silver plate on copper undercoat

Product Code	Capacitance (±20%) UOS	Dielectric	Rated Voltage (Vdc)	DWV (Vdc)	Typical No-Load Insertion Loss (dB)					
					0.01MHz	0.1MHz	1MHz	10MHz	100MHz	1GHz
*SFBBDT5000100ZC	10pF -20% / +80%	COG/NPO	500#	750	-	-	-	-	-	9
SFBBDT5000150ZC	15pF -20% / +80%				-	-	-	-	-	11
SFBBDT5000220ZC	22pF -20% / +80%				-	-	-	-	1	14
SFBBDT5000330ZC	33pF -20% / +80%				-	-	-	-	2	18
*SFBBDT5000470ZC	47pF -20% / +80%				-	-	-	-	4	20
*SFBBDT5000680MC	68pF				-	-	-	-	6	23
*SFBBDT5000101MC	100pF				-	-	-	-	9	27
SFBBDT5000151MC	150pF				-	-	-	-	12	30
*SFBBDT5000221MC	220pF				-	-	-	-	15	33
*SFBBDT5000331MC	330pF				-	-	-	1	19	36
*SFBBDT5000471MX	470pF	1X7R	500#	750	-	-	-	2	21	40
SFBBDT5000681MX	680pF				-	-	-	4	24	43
*SFBBDT5000102MX	1.0nF	X7R	500#	750	-	-	-	7	28	47
SFBBDT5000152MX	1.5nF				-	-	-	10	30	50
*SFBBDT5000222MX	2.2nF				-	-	-	13	34	53
SFBBDT5000332MX	3.3nF				-	-	-	17	38	57
*SFBBDT5000472MX	4.7nF				-	-	-	19	40	59
SFBBDT5000682MX	6.8nF				-	-	1	23	43	63
*SFBBDT5000103MX	10nF				-	-	4	26	45	66
*SFBBDT5000153MX	15nF				-	-	7	29	47	68
*SFBBDT5000223MX	22nF				-	-	10	33	49	70
SFBBDT5000333MX	33nF				-	-	14	36	50	>70
*SFBBDT2000473MX	47nF		200	500	-	1	17	39	52	>70
SFBBDT2000683MX	68nF		-	2	20	42	57	>70		
*SFBBDT1000104MX	100nF		100	250	-	4	22	46	62	>70
*SFBBDT0500154MX	150nF		50	125	-	7	25	49	68	>70

Also rated for operation at 115Vac 400Hz. Self heating will occur - evaluation in situ recommended. * Recommended values. † Also available in COG/NPO.

Ordering Information - SFBBDT range

SF	B	D	T	500	0102	M	X	O
Type	Case style	Thread	Electrical configuration	Voltage (dc)	Capacitance in picofarads (pF)	Tolerance	Dielectric	Hardware
Syfer Filter	4.75mm Hex Head	12-32 UNEF	T = T Filter	050 = 50V 100 = 100V 200 = 200V 500 = 500V	First digit is 0. Second and third digits are significant figures of capacitance code. The fourth digit is number of zeros following Example: 0101 = 100pF 0332 = 3300pF	M = ±20% Z = -20+80%	C = COG/NPO X = X7R	O = Without 1 = With

Note: The addition of a 4-digit numerical suffix code can be used to denote changes to the standard part. Options include for example: change of finish / alternative voltage rating / non-standard intermediate capacitance values / test requirements. Please refer specific requests to the factory.

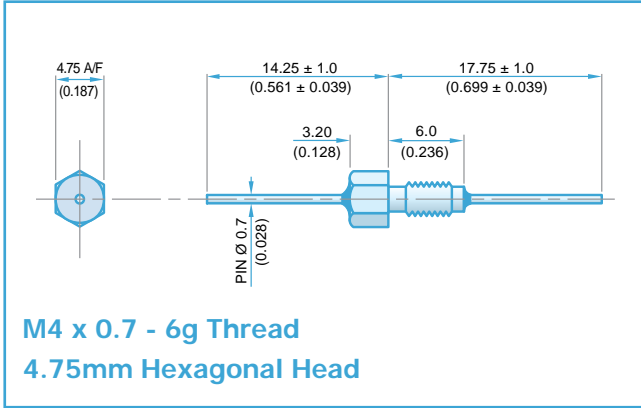

Electrical Details	
Electrical Configuration	C Filter
Capacitance Measurement	@ 1000hr Point
Current Rating	10A
Insulation Resistance (IR)	10GΩ or 1000ΩF
Temperature Rating	-55°C to +125°C
Ferrite Inductance (Typical)	N/A
Mechanical Details	
Head (A/F)	4.75mm (0.187")
Nut A/F	6.35mm (0.250")
Washer diameter	8mm (0.315")
Mounting Torque	0.5Nm (4.42bf in) max. if using nut 0.25Nm (2.41lbf in) max. into tapped hole
Mounting Hole Diameter	4.2mm ±0.1 (0.165" ±0.004")
Max. Panel Thickness	2.9mm (0.114")
Weight (Typical)	1.2g (0.04oz)
Finish	Silver plate on copper undercoat

Product Code	Capacitance (±20%) UOS	Dielectric	Rated Voltage (Vdc)	DWV (Vdc)	Typical No-Load Insertion Loss (dB)					
					0.01MHz	0.1MHz	1MHz	10MHz	100MHz	1GHz
*SFBLC5000100ZC	10pF -20% / +80%	COG/NPO	500#	750	-	-	-	-	-	4
SFBLC5000150ZC	15pF -20% / +80%				-	-	-	-	-	7
SFBLC5000220ZC	22pF -20% / +80%				-	-	-	-	-	10
SFBLC5000330ZC	33pF -20% / +80%				-	-	-	-	-	12
*SFBLC5000470ZC	47pF -20% / +80%				-	-	-	-	1	15
*SFBLC5000680MC	68pF				-	-	-	-	2	18
*SFBLC5000101MC	100pF				-	-	-	-	4	22
SFBLC5000151MC	150pF				-	-	-	-	7	25
*SFBLC5000221MC	220pF				-	-	-	-	10	29
*SFBLC5000331MC	330pF				-	-	-	-	13	33
*SFBLC5000471MX	470pF	†X7R	500#	750	-	-	-	1	16	35
SFBLC5000681MX	680pF	-			-	-	2	19	36	
*SFBLC5000102MX	1.0nF	X7R			-	-	-	4	23	41
SFBLC5000152MX	1.5nF				-	-	-	7	26	45
*SFBLC5000222MX	2.2nF				-	-	-	10	30	50
SFBLC5000332MX	3.3nF				-	-	-	13	33	52
*SFBLC5000472MX	4.7nF				-	-	1	16	36	55
SFBLC5000682MX	6.8nF				-	-	2	19	39	57
*SFBLC5000103MX	10nF				-	-	4	22	41	60
*SFBLC5000153MX	15nF				-	-	7	25	44	62
*SFBLC5000223MX	22nF		-	-	10	29	46	65		
SFBLC5000333MX	33nF		-	-	13	33	48	68		
*SFBLC2000473MX	47nF		200	500	-	1	16	35	50	70
SFBLC2000683MX	68nF		-	2	19	39	54	>70		
*SFBLC1000104MX	100nF		100	250	-	4	22	41	57	>70
*SFBLC0500154MX	150nF		50	125	-	7	25	45	60	>70

Also rated for operation at 115Vac 400Hz. Self heating will occur - evaluation in situ recommended. * Recommended values. † Also available in COG/NPO.

Ordering Information - SFBLC range

SF	B	L	C	500	0102	M	X	O
Type	Case style	Thread	Electrical configuration	Voltage (dc)	Capacitance in picofarads (pF)	Tolerance	Dielectric	Hardware
Syfer Filter	4.75mm Hex Head	M4	C = C Filter	050 = 50V 100 = 100V 200 = 200V 500 = 500V	First digit is 0. Second and third digits are significant figures of capacitance code. The fourth digit is number of zeros following Example: 0101 = 100pF 0332 = 3300pF	M = ±20% Z = -20+80%	C = COG/NPO X = X7R	O = Without 1 = With

Note: The addition of a 4-digit numerical suffix code can be used to denote changes to the standard part. Options include for example: change of finish / alternative voltage rating / non-standard intermediate capacitance values / test requirements. Please refer specific requests to the factory.

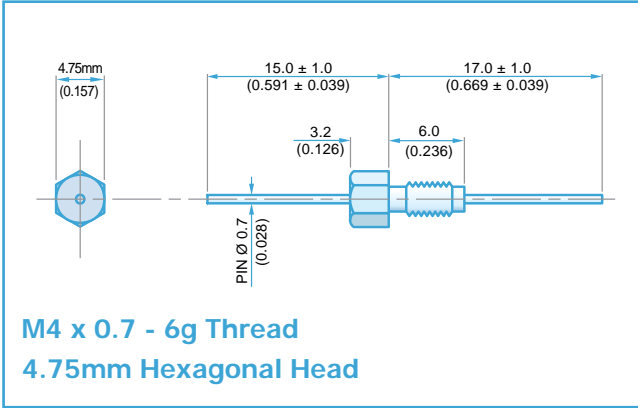
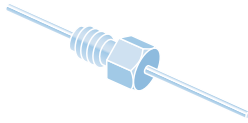

Electrical Details	
Electrical Configuration	L-C Filter
Capacitance Measurement	@ 1000hr Point
Current Rating	10A
Insulation Resistance (IR)	10GΩ or 1000ΩF
Temperature Rating	-55°C to +125°C
Ferrite Inductance (Typical)	50nH

Mechanical Details	
Body Flange Diameter	4.75mm (0.187")
Head (A/F)	6.0mm (0.236")
Nut A/F	8.0mm (0.315")
Mounting Torque	0.5Nm (4.42lbf in) max. if using nut 0.25Nm (2.21lbf in) max. into tapped hole
Mounting Hole Diameter	4.2mm ± 0.1 (0.165" ± 0.004")
Max. Panel Thickness	2.9mm (0.114")
Weight (Typical)	1.2g (0.04oz)
Finish	Silver plate on copper undercoat

Product Code	Capacitance (±20%) UOS	Dielectric	Rated Voltage (Vdc)	DWV (Vdc)	Typical No-Load Insertion Loss (dB)					
					0.01MHz	0.1MHz	1MHz	10MHz	100MHz	1GHz
*SFBL5000100ZC	10pF -20% / +80%	COG/NPO	500#	750	-	-	-	-	-	6
SFBL5000150ZC	15pF -20% / +80%				-	-	-	-	-	9
SFBL5000220ZC	22pF -20% / +80%				-	-	-	-	-	12
SFBL5000330ZC	33pF -20% / +80%				-	-	-	-	1	15
*SFBL5000470ZC	47pF -20% / +80%				-	-	-	-	2	19
*SFBL5000680MC	68pF				-	-	-	-	4	20
*SFBL5000101MC	100pF				-	-	-	-	7	24
SFBL5000151MC	150pF				-	-	-	-	10	27
*SFBL5000221MC	220pF				-	-	-	-	12	30
*SFBL5000331MC	330pF				-	-	-	1	16	34
*SFBL5000471MX	470pF	1X7R	500#	750	-	-	-	2	19	38
SFBL5000681MX	680pF				-	-	-	3	22	41
*SFBL5000102MX	1.0nF	X7R	500#	750	-	-	-	6	25	44
SFBL5000152MX	1.5nF				-	-	-	9	29	48
*SFBL5000222MX	2.2nF				-	-	-	12	31	51
SFBL5000332MX	3.3nF				-	-	-	15	35	54
*SFBL5000472MX	4.7nF				-	-	1	18	39	57
SFBL5000682MX	6.8nF				-	-	2	21	41	60
*SFBL5000103MX	10nF				-	-	4	23	43	63
*SFBL5000153MX	15nF				-	-	7	27	46	66
*SFBL5000223MX	22nF				-	-	10	30	48	68
SFBL5000333MX	33nF				-	-	13	34	50	70
*SFBL2000473MX	47nF	-	200	500	-	1	17	37	51	>70
SFBL2000683MX	68nF	-	200	500	-	2	20	40	55	>70
*SFBL1000104MX	100nF	-	100	250	-	4	22	44	60	>70
*SFBL0500154MX	150nF	-	50	125	-	7	25	47	62	>70

Also rated for operation at 115Vac 400Hz. Self heating will occur - evaluation in situ recommended. * Recommended values. † Also available in COG/NPO.

Ordering Information - SFBL range

SF	B	L	L	500	0102	M	X	O
Type	Case style	Thread	Electrical configuration	Voltage (dc)	Capacitance in picofarads (pF)	Tolerance	Dielectric	Nuts & Washers
Syfer Filter	4.75mm Hex Head	M4	L = L-C Filter	050 = 50V 100 = 100V 200 = 200V 500 = 500V	First digit is 0. Second and third digits are significant figures of capacitance code. The fourth digit is number of zeros following Example: 0101 = 100pF 0332 = 3300pF	M = ±20% Z = -20+80%	C = COG/NPO X = X7R	0 = Without 1 = With

Note: The addition of a 4-digit numerical suffix code can be used to denote changes to the standard part. Options include for example: change of finish / alternative voltage rating / non-standard intermediate capacitance values / test requirements. Please refer specific requests to the factory.

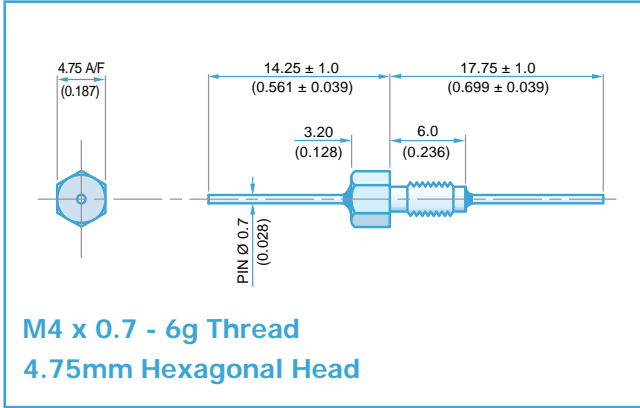

Electrical Details

Electrical Configuration	PI Filter	
Capacitance Measurement	@ 1000hr Point	
Current Rating	10A	
Insulation Resistance (IR)	10GΩ or 1000ΩF	
Temperature Rating	-55°C to +125°C	
Ferrite Inductance (Typical)	75nH	

Mechanical Details

Head (A/F)	4.75mm (0.187")
Nut A/F	6.0mm (0.236")
Washer diameter	7.90mm (0.311")
Mounting Torque	0.5Nm (4.42lbf in) max. if using nut 0.25Nm (2.21lbf in) max. into tapped hole
Mounting Hole Diameter	4.2mm ±0.1 (0.165" ±0.004")
Max. Panel Thickness	2.9mm (0.114")
Weight (Typical)	1.2g (0.04oz)
Finish	Silver plate on copper undercoat

Product Code	Capacitance (-20%+80%)	Dielectric	Rated Voltage (Vdc)	DWV (Vdc)	Typical No-Load Insertion Loss (dB)					
					0.01MHz	0.1MHz	1MHz	10MHz	100MHz	1GHz
*SFBLP5000200ZC	20pF	COG/NPO	500#	750	-	-	-	-	1	11
SFBLP5000440ZC	44pF				-	-	-	-	3	19
SFBLP5000940ZC	94pF				-	-	-	-	6	25
*SFBLP5000201ZC	200pF				-	-	-	-	11	33
SFBLP5000441ZC	440pF				-	-	-	2	18	45
SFBLP5000941ZX	940pF	X7R			-	-	-	5	25	60
*SFBLP5000202ZX	2nF				-	-	-	10	40	70
SFBLP5000442ZX	4.4nF				-	-	1	17	47	>70
*SFBLP5000942ZX	9.4nF				-	-	4	24	60	>70
*SFBLP2000203ZX	20nF				-	200	500	-	-	9
*SFBLP1000443ZX	44nF	-	100	250	-	0	14	42	>70	>70
*SFBLP0500943ZX	94nF	-	50	125	-	2	18	57	>70	>70

Also rated for operation at 115Vac 400Hz. Self heating will occur - evaluation in situ recommended. * Recommended values. † Also available in COG/NPO.

Ordering Information - SFBLP range

SF	B	L	P	050	0943	Z	X	O
Type	Case style	Thread	Electrical configuration	Voltage (dc)	Capacitance in picofarads (pF)	Tolerance	Dielectric	Nuts & Washers
Syfer Filter	4.75mm Hex Head	M4	P = Pi Filter	050 = 50V 100 = 100V 200 = 200V 500 = 500V	First digit is 0. Second and third digits are significant figures of capacitance code. The fourth digit is number of zeros following Example: 0201 = 200pF 0943 = 94000pF	Z = -20+80%	C = COG/NPO X = X7R	O = Without 1 = With

Note: The addition of a 4-digit numerical suffix code can be used to denote changes to the standard part. Options include for example: change of finish / alternative voltage rating / non-standard intermediate capacitance values / test requirements. Please refer specific requests to the factory.

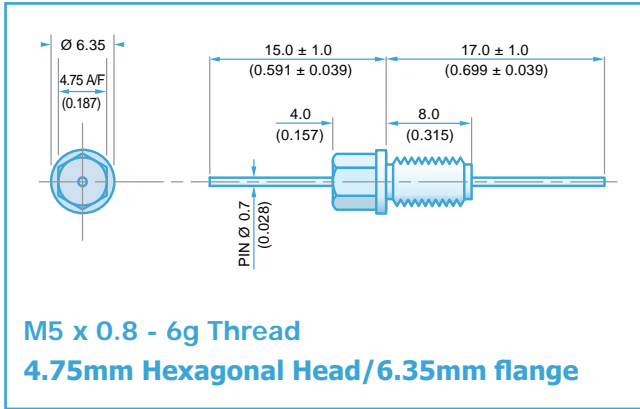
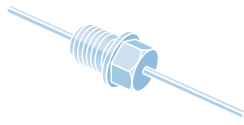

Electrical Details

Electrical Configuration	C Filter
Capacitance Measurement	@ 1000hr Point
Current Rating	10A
Insulation Resistance (IR)	10GΩ or 1000ΩF
Temperature Rating	-55°C to +125°C
Ferrite Inductance (Typical)	Not Applicable

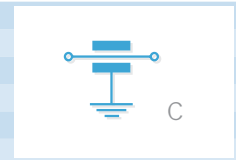

Mechanical Details

Body Flange Diameter	6.35mm (0.250")
Head (A/F)	4.75mm (0.187")
Nut A/F	6.0mm (0.236")
Washer Diameter	9.1mm (0.358")
Mounting Torque	0.6Nm (5.31lbf in) max. if using nut 0.3Nm (2.65lbf in) max. into tapped hole
Mounting Hole Diameter	5.2mm ±0.1 (0.205 ±0.004")
Max. Panel Thickness	4.9mm (0.193")
Weight (Typical)	1.5g (0.05oz)
Finish	Silver plate on copper undercoat

Product Code	Capacitance (±20%) UOS	Dielectric	Rated Voltage (Vdc)	DWV (Vdc)	Typical No-Load Insertion Loss (dB)					
					0.01MHz	0.1MHz	1MHz	10MHz	100MHz	1GHz
*SFBMC5000100ZC	10pF -20% / +80%	COG/NPO	500#	750	-	-	-	-	-	4
SFBMC5000150ZC	15pF -20% / +80%				-	-	-	-	-	7
SFBMC5000220ZC	22pF -20% / +80%				-	-	-	-	-	10
SFBMC5000330ZC	33pF -20% / +80%				-	-	-	-	-	12
*SFBMC5000470ZC	47pF -20% / +80%				-	-	-	-	1	15
*SFBMC5000680MC	68pF				-	-	-	-	2	18
*SFBMC5000101MC	100pF				-	-	-	-	4	22
SFBMC5000151MC	150pF				-	-	-	-	7	25
*SFBMC5000221MC	220pF				-	-	-	-	10	29
*SFBMC5000331MC	330pF				-	-	-	-	13	33
*SFBMC5000471MX	470pF	†X7R	500#	750	-	-	-	1	16	35
SFBMC5000681MX	680pF	-			-	-	2	19	36	
*SFBMC5000102MX	1.0nF	X7R			-	-	-	4	23	41
SFBMC5000152MX	1.5nF				-	-	-	7	26	45
*SFBMC5000222MX	2.2nF				-	-	-	10	30	50
SFBMC5000332MX	3.3nF				-	-	-	13	33	52
*SFBMC5000472MX	4.7nF				-	-	1	16	36	55
SFBMC5000682MX	6.8nF				-	-	2	19	39	57
*SFBMC5000103MX	10nF				-	-	4	22	41	60
*SFBMC5000153MX	15nF				-	-	7	25	44	62
*SFBMC5000223MX	22nF		-	-	10	29	46	65		
SFBMC5000333MX	33nF		-	-	13	33	48	68		
*SFBMC2000473MX	47nF		200	500	-	1	16	35	50	70
SFBMC2000683MX	68nF		-	-	-	2	19	39	54	>70
*SFBMC1000104MX	100nF		100	250	-	4	22	41	57	>70
*SFBMC0500154MX	150nF		50	125	-	7	25	45	60	>70

Also rated for operation at 115Vac 400Hz. Self heating will occur - evaluation in situ recommended. * Recommended values. † Also available in COG/NPO.

Ordering Information - SFBMC range

SF	B	M	C	500	0102	M	X	O
Type	Case style	Thread	Electrical configuration	Voltage (dc)	Capacitance in picofarads (pF)	Tolerance	Dielectric	Nuts & Washers
Syfer Filter	4.75mm Hex Head	M5	C = C Filter	050 = 50V 100 = 100V 200 = 200V 500 = 500V	First digit is 0. Second and third digits are significant figures of capacitance code. The fourth digit is number of zeros following Example: 0101 = 100pF 0332 = 3300pF	M = ±20% Z = -20+80%	C = COG/NPO X = X7R	0 = Without 1 = With

Note: The addition of a 4-digit numerical suffix code can be used to denote changes to the standard part. Options include for example: change of finish / alternative voltage rating / non-standard intermediate capacitance values / test requirements. Please refer specific requests to the factory.

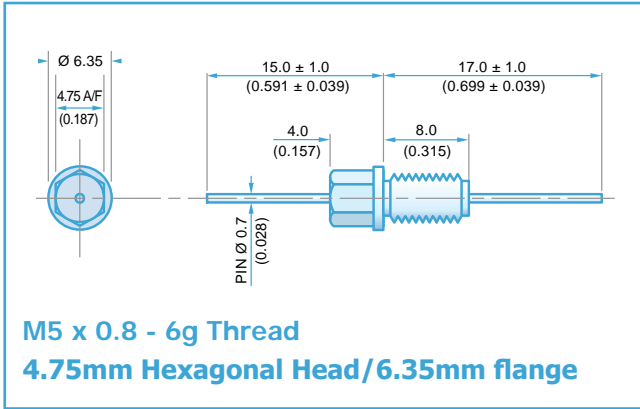
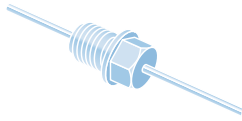

Electrical Details

Electrical Configuration	L-C Filter
Capacitance Measurement	@ 1000hr Point
Current Rating	10A
Insulation Resistance (IR)	10GΩ or 1000ΩF
Temperature Rating	-55°C to +125°C
Ferrite Inductance (Typical)	500nH

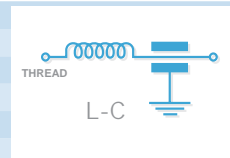

Mechanical Details

Body Flange Diameter	6.35mm (0.250")
Head (A/F)	4.75mm (0.187")
Nut A/F	6.0mm (0.236")
Washer diameter	9.1mm (0.358")
Mounting Torque	0.6Nm (5.31lbf in) max. if using nut 0.3Nm (2.65lbf in) max. into tapped hole
Mounting Hole Diameter	5.2mm ±0.1 (0.205" ±0.004")
Max. Panel Thickness	4.9mm (0.193")
Weight (Typical)	1.5g (0.05oz)
Finish	Silver plate on copper undercoat

Product Code	Capacitance (±20%) UOS	Dielectric	Rated Voltage (Vdc)	DWV (Vdc)	Typical No-Load Insertion Loss (dB)					
					0.01MHz	0.1MHz	1MHz	10MHz	100MHz	1GHz
*SFBML5000100ZC	10pF -20% / +80%	COG/NPO	500#	750	-	-	-	-	-	6
SFBML5000150ZC	15pF -20% / +80%				-	-	-	-	-	9
SFBML5000220ZC	22pF -20% / +80%				-	-	-	-	-	12
SFBML5000330ZC	33pF -20% / +80%				-	-	-	-	1	15
*SFBML5000470ZC	47pF -20% / +80%				-	-	-	-	2	19
*SFBML5000680MC	68pF				-	-	-	-	4	20
*SFBML5000101MC	100pF				-	-	-	-	7	24
SFBML5000151MC	150pF				-	-	-	-	10	27
*SFBML5000221MC	220pF				-	-	-	-	12	30
*SFBML5000331MC	330pF				-	-	-	1	16	34
*SFBML5000471MX	470pF	†X7R	500#	750	-	-	-	2	19	38
SFBML5000681MX	680pF	-			-	-	3	22	41	
*SFBML5000102MX	1.0nF	X7R			-	-	-	6	25	44
SFBML5000152MX	1.5nF				-	-	-	9	29	48
*SFBML5000222MX	2.2nF				-	-	-	12	31	51
SFBML5000332MX	3.3nF				-	-	-	15	35	54
*SFBML5000472MX	4.7nF				-	-	1	18	39	57
SFBML5000682MX	6.8nF				-	-	2	21	41	60
*SFBML5000103MX	10nF				-	-	4	23	43	63
*SFBML5000153MX	15nF				-	-	7	27	46	66
*SFBML5000223MX	22nF		-	-	10	30	48	68		
SFBML5000333MX	33nF		-	-	13	34	50	70		
*SFBML2000473MX	47nF		200	500	-	1	17	37	51	>70
SFBML2000683MX	68nF		-	2	20	40	55	>70		
*SFBML1000104MX	100nF		100	250	-	4	22	44	60	>70
*SFBML0500154MX	150nF		50	125	-	7	25	47	62	>70

Also rated for operation at 115Vac 400Hz. Self heating will occur - evaluation in situ recommended. * Recommended values. † Also available in COG/NPO.

Ordering Information - SFBML range

SF	B	M	L	500	0102	M	X	O
Type	Case style	Thread	Electrical configuration	Voltage (dc)	Capacitance in picofarads (pF)	Tolerance	Dielectric	Nuts & Washers
Syfer Filter	4.75mm Hex Head	M5	L = L-C Filter	050 = 50V 100 = 100V 200 = 200V 500 = 500V	First digit is 0. Second and third digits are significant figures of capacitance code. The fourth digit is number of zeros following Example: 0101 = 100pF 0332 = 3300pF	M = ±20% Z = -20+80%	C = COG/NPO X = X7R	0 = Without 1 = With

Note: The addition of a 4-digit numerical suffix code can be used to denote changes to the standard part. Options include for example: change of finish / alternative voltage rating / non-standard intermediate capacitance values / test requirements. Please refer specific requests to the factory.

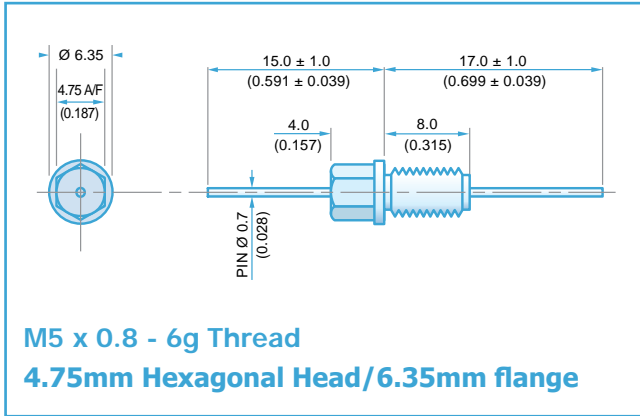
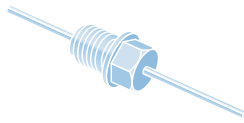

Electrical Details

Electrical Configuration	PI Filter
Capacitance Measurement	@ 1000hr Point
Current Rating	10A
Insulation Resistance (IR)	10GΩ or 1000ΩF
Temperature Rating	-55°C to +125°C
Ferrite Inductance (Typical)	250nH

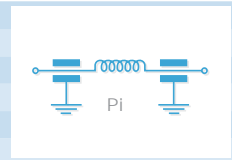

Mechanical Details

Body Flange Diameter	6.35mm (0.250")
Head A/F	4.75mm (0.187")
Nut A/F	6mm (0.236")
Washer Diameter	9.1mm (0.358")
Mounting Torque	0.6Nm (5.31lbf in) max. if using nut 0.3Nm (2.65lbf in) max. into tapped hole
Mounting Hole Diameter	5.2mm ± 0.1 (0.205" ± 0.004")
Max. Panel Thickness	4.9mm (0.193")
Weight (Typical)	1.5g (0.05oz)
Finish	Silver plate on copper undercoat

Product Code	Capacitance (±20%) UOS	Dielectric	Rated Voltage (Vdc)	DWV (Vdc)	Typical No-Load Insertion Loss (dB)								
					0.01MHz	0.1MHz	1MHz	10MHz	100MHz	1GHz			
*SFBMP5000200ZC	20pF -20% / +80%	COG/NPO	500#	750	-	-	-	-	1	11			
SFBMP5000300ZC	30pF -20% / +80%				-	-	-	-	2	15			
SFBMP5000440ZC	44pF -20% / +80%				-	-	-	-	3	19			
SFBMP5000660ZC	66pF -20% / +80%				-	-	-	-	4	23			
*SFBMP5000940ZC	94pF -20% / +80%				-	-	-	-	6	29			
*SFBMP500136PMC	136pF				-	-	-	-	8	35			
*SFBMP5000201MC	200pF				-	-	-	-	11	41			
SFBMP5000301MC	300pF				-	-	-	1	15	50			
*SFBMP5000441MC	440pF				-	-	-	2	20	57			
*SFBMP5000661MC	660pF				-	-	-	3	25	65			
*SFBMP5000941MX	940pF				†X7R	-	-	-	5	31	68		
SFBMP5001N36MX	1.36nF					-	-	-	7	37	>70		
*SFBMP5000202MX	2nF	X7R				-	-	-	10	44	>70		
SFBMP5000302MX	3nF					-	-	-	13	51	>70		
*SFBMP5000442MX	4.4nF					-	-	1	17	59	>70		
SFBMP5000662MX	6.6nF					-	-	2	21	64	>70		
*SFBMP5000942MX	9.4nF					-	-	4	27	68	>70		
SFBMP50013N6MX	13.6nF					-	-	6	34	>70	>70		
*SFBMP5000203MX	20nF					-	-	9	40	>70	>70		
*SFBMP5000303MX	30nF					-	-	12	48	>70	>70		
*SFBMP5000443MX	44nF					-	-	1	54	>70	>70		
SFBMP5000663MX	66nF					-	-	2	63	>70	>70		
*SFBMP2000943MX	94nF				-	200	500	-	4	18	68	>70	>70
SFBMP200136NMX	136nF				-	-	-	-	8	25	>70	>70	>70
*SFBMP1000204MX	200nF	-	100	250	-	10	27	>70	>70	>70			
*SFBMP0500304MX	300nF	-	50	125	-	13	30	>70	>70	>70			

Also rated for operation at 115Vac 400Hz. Self heating will occur - evaluation in situ recommended. * Recommended values. † Also available in COG/NPO.

Ordering Information - SFBMP range

SF	B	M	P	200	0943	M	X	O
Type	Case style	Thread	Electrical configuration	Voltage (dc)	Capacitance in picofarads (pF)	Tolerance	Dielectric	Nuts & Washers
Syfer Filter	4.75mm Hex Head	M5	P = Pi Filter	050 = 50V 100 = 100V 200 = 200V 500 = 500V	First digit is 0. Second and third digits are significant figures of capacitance code. The fourth digit is number of zeros following Example: 0201 = 200pF 0943 = 9400pF	M = ±20% Z = -20+80%	C = COG/NPO X = X7R	O = Without

Note: The addition of a 4-digit numerical suffix code can be used to denote changes to the standard part. Options include for example: change of finish / alternative voltage rating / non-standard intermediate capacitance values / test requirements. Please refer specific requests to the factory.

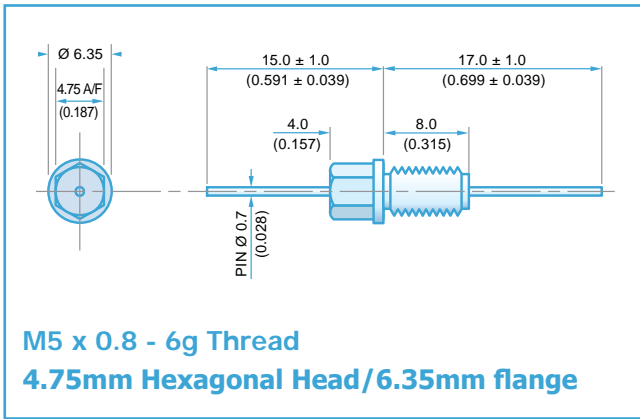
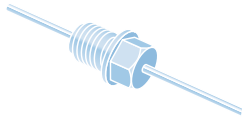

Electrical Details

Electrical Configuration	T Filter
Capacitance Measurement	@ 1000hr Point
Current Rating	10A
Insulation Resistance (IR)	10GΩ or 1000ΩF
Temperature Rating	-55°C to +125°C
Ferrite Inductance (Typical)	450nH

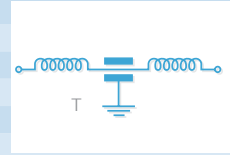

Mechanical Details

Body Flange Diameter	6.35mm (0.250")
Head (A/F)	4.75mm (0.187")
Nut A/F	6.0mm (0.236")
Washer diameter	9.1mm (0.358")
Mounting Torque	0.6Nm (5.31lbf in) max. if using nut 0.3Nm (2.65lbf in) max. into tapped hole
Mounting Hole Diameter	5.2mm ±0.1 (0.205" ±0.004")
Max. Panel Thickness	4.9mm (0.193")
Weight (Typical)	1.5g (0.05oz)
Finish	Silver plate on copper undercoat

Product Code	Capacitance (±20%) UOS	Dielectric	Rated Voltage (Vdc)	DWV (Vdc)	Typical No-Load Insertion Loss (dB)					
					0.01MHz	0.1MHz	1MHz	10MHz	100MHz	1GHz
*SFBMT5000100ZC	10pF -20% / +80%	COG/NPO	500#	750	-	-	-	-	-	9
SFBMT5000150ZC	15pF -20% / +80%				-	-	-	-	-	11
SFBMT5000220ZC	22pF -20% / +80%				-	-	-	-	1	14
SFBMT5000330ZC	33pF -20% / +80%				-	-	-	-	2	18
*SFBMT5000470ZC	47pF -20% / +80%				-	-	-	-	4	20
*SFBMT5000680MC	68pF				-	-	-	-	6	23
*SFBMT5000101MC	100pF				-	-	-	-	9	27
SFBMT5000151MC	150pF				-	-	-	-	12	30
*SFBMT5000221MC	220pF				-	-	-	-	15	33
*SFBMT5000331MC	330pF				-	-	-	1	19	36
*SFBMT5000471MX	470pF	†X7R	500#	750	-	-	-	2	21	40
SFBMT5000681MX	680pF	-			-	-	4	24	43	
*SFBMT5000102MX	1.0nF	X7R			-	-	-	7	28	47
SFBMT5000152MX	1.5nF				-	-	-	10	30	50
*SFBMT5000222MX	2.2nF				-	-	-	13	34	53
SFBMT5000332MX	3.3nF				-	-	-	17	38	57
*SFBMT5000472MX	4.7nF				-	-	-	19	40	59
SFBMT5000682MX	6.8nF				-	-	1	23	43	63
*SFBMT5000103MX	10nF				-	-	4	26	45	66
*SFBMT5000153MX	15nF				-	-	7	29	47	68
*SFBMT5000223MX	22nF		-	-	10	33	49	70		
SFBMT5000333MX	33nF		-	-	14	36	50	>70		
*SFBMT2000473MX	47nF		200	500	-	1	17	39	52	>70
SFBMT2000683MX	68nF		-	2	20	42	57	>70		
*SFBMT1000104MX	100nF		100	250	-	4	22	46	62	>70
*SFBMT0500154MX	150nF		50	125	-	7	25	49	68	>70

Also rated for operation at 115Vac 400Hz. Self heating will occur - evaluation in situ recommended. * Recommended values. † Also available in COG/NPO.

Ordering Information - SFBMT range

SF	B	M	T	500	0102	M	X	O
Type	Case style	Thread	Electrical configuration	Voltage (dc)	Capacitance in picofarads (pF)	Tolerance	Dielectric	Nuts & Washers
Syfer Filter	4.75mm Hex head	M5	T = T Filter	050 = 50V 100 = 100V 200 = 200V 500 = 500V	First digit is 0. Second and third digits are significant figures of capacitance code. The fourth digit is number of zeros following Example: 0101 = 100pF 0332 = 3300pF	M = ±20% Z = -20+80%	C = COG/NPO X = X7R	O = Without

Note: The addition of a 4-digit numerical suffix code can be used to denote changes to the standard part. Options include for example: change of finish / alternative voltage rating / non-standard intermediate capacitance values / test requirements. Please refer specific requests to the factory.

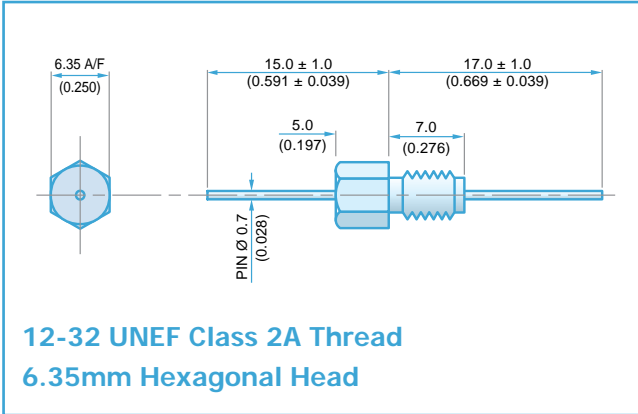

Electrical Details

Electrical Configuration	C Filter
Capacitance Measurement	@ 1000hr Point
Current Rating	10A
Insulation Resistance (IR)	10GΩ or 1000ΩF
Temperature Rating	-55°C to +125°C
Ferrite Inductance (Typical)	Not Applicable

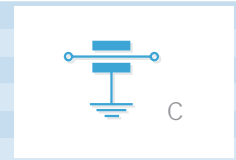

Mechanical Details

Head Diameter	6.35mm (0.250")
Nut A/F	7.92mm (0.312")
Washer Diameter	9.40mm (0.370")
Mounting Torque	0.6Nm (5.31lbf in) max. if using nut 0.3Nm (2.65lbf in) max. into tapped hole
Mounting Hole Diameter	5.7mm ± 0.1 (0.224" ± 0.004")
Max. Panel Thickness	3.9mm (0.154")
Weight (Typical)	1.8g (0.06oz)
Finish	Silver plate on copper undercoat

Product Code	Capacitance (±20%) UOS	Dielectric	Rated Voltage (Vdc)	DWV (Vdc)	Typical No-Load Insertion Loss (dB)										
					0.01MHz	0.1MHz	1MHz	10MHz	100MHz	1GHz					
*SFCDC5000100ZC	10pF -20% / +80%	COG/NPO	500#	750	-	-	-	-	-	4					
SFCDC5000150ZC	15pF -20% / +80%				-	-	-	-	-	7					
SFCDC5000220ZC	22pF -20% / +80%				-	-	-	-	-	10					
SFCDC5000330ZC	33pF -20% / +80%				-	-	-	-	-	12					
*SFCDC5000470ZC	47pF -20% / +80%				-	-	-	-	1	15					
*SFCDC5000680MC	68pF				-	-	-	-	2	18					
*SFCDC5000101MC	100pF				-	-	-	-	4	22					
SFCDC5000151MC	150pF				-	-	-	-	7	25					
*SFCDC5000221MC	220pF				-	-	-	-	10	29					
*SFCDC5000331MC	330pF				-	-	-	-	19	33					
*SFCDC5000471MX	470pF	†X7R			200	500	-	-	-	1	16	35			
SFCDC5000681MX	680pF	-					-	-	2	19	36				
*SFCDC5000102MX	1.0nF	X7R					-	-	-	4	23	41			
SFCDC5000152MX	1.5nF						-	-	-	7	26	45			
*SFCDC5000222MX	2.2nF						-	-	-	10	30	50			
SFCDC5000332MX	3.3nF						-	-	-	13	33	52			
*SFCDC5000472MX	4.7nF						-	-	1	16	36	55			
SFCDC5000682MX	6.8nF						-	-	-	19	39	57			
*SFCDC5000103MX	10nF						-	-	4	22	41	60			
*SFCDC5000153MX	15nF						-	-	7	25	44	62			
*SFCDC5000223MX	22nF						-	-	10	29	46	65			
SFCDC5000333MX	33nF						-	-	13	33	48	68			
*SFCDC5000473MX	47nF						-	-	1	16	35	50	70		
SFCDC5000683MX	68nF						-	-	2	19	39	54	>70		
SFCDC5000104MX	100nF						-	-	4	22	41	57	>70		
SFCDC5000154MX	150nF						-	-	7	25	45	60	>70		
*SFCDC2000224MX	220nF							100	250	-	13	33	52	66	>70
SFCDC1000334MX	330nF									1	16	35	55	68	>70
*SFCDC1000474MX	470nF									2	19	38	58	70	>70
SFCDC0500684MX	680nF							50	125						

Also rated for operation at 115Vac 400Hz. Self heating will occur - evaluation in situ recommended. * Recommended values. † Also available in COG/NPO.

Ordering Information - SFCDC range

SF	C	D	C	500	0102	M	X	O
Type	Case style	Thread	Electrical configuration	Voltage (dc)	Capacitance in picofarads (pF)	Tolerance	Dielectric	Nuts & Washers
Syfer Filter	6.35mm Hex Head	12-32 UNEF	C = C Filter	050 = 50V 100 = 100V 200 = 200V 500 = 500V	First digit is 0. Second and third digits are significant figures of capacitance code. The fourth digit is number of zeros following Example: 0101 = 100pF 0332 = 3300pF	M = ±20% Z = -20+80%	C = COG/NPO X = X7R	0 = Without 1 = With

Note: The addition of a 4-digit numerical suffix code can be used to denote changes to the standard part. Options include for example: change of finish / alternative voltage rating / non-standard intermediate capacitance values / test requirements. Please refer specific requests to the factory.

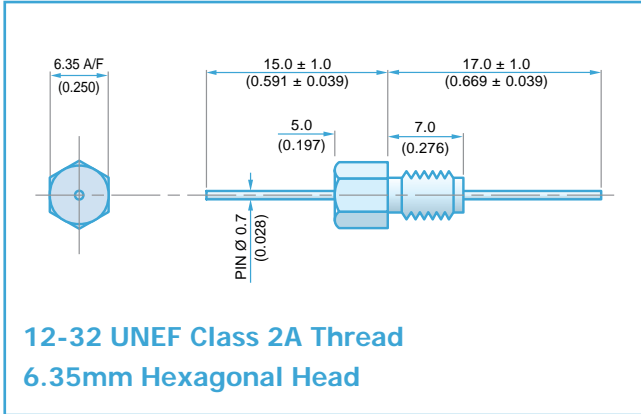

Electrical Details	
Electrical Configuration	L-C Filter
Capacitance Measurement	@ 1000hr Point
Current Rating	10A
Insulation Resistance (IR)	10GΩ or 1000ΩF
Temperature Rating	-55°C to +125°C
Ferrite Inductance (Typical)	500nH

THREAD
L-C

Mechanical Details	
Head Diameter	6.35mm (0.250")
Nut A/F	7.92mm (0.312")
Washer Diameter	9.40mm (0.370")
Mounting Torque	0.6Nm (5.31lbf in) max. if using nut 0.3Nm (2.65lbf in) max. into tapped hole
Mounting Hole Diameter	5.7mm ± 0.1 (0.224" ± 0.004")
Max. Panel Thickness	3.9mm (0.154")
Weight (Typical)	1.8g (0.06oz)
Finish	Silver plate on copper undercoat

Product Code	Capacitance (±20%) UOS	Dielectric	Rated Voltage (Vdc)	DWV (Vdc)	Typical No-Load Insertion Loss (dB)								
					0.01MHz	0.1MHz	1MHz	10MHz	100MHz	1GHz			
*SFCDL5000100ZC	10pF -20% / +80%	COG/NPO	500#	750	-	-	-	-	-	6			
SFCDL5000150ZC	15pF -20% / +80%				-	-	-	-	-	9			
SFCDL5000220ZC	22pF -20% / +80%				-	-	-	-	-	12			
SFCDL5000330ZC	33pF -20% / +80%				-	-	-	-	1	15			
*SFCDL5000470ZC	47pF -20% / +80%				-	-	-	-	2	19			
*SFCDL5000680MC	68pF				-	-	-	-	4	20			
*SFCDL5000101MC	100pF				-	-	-	-	7	24			
SFCDL5000151MC	150pF				-	-	-	-	10	27			
*SFCDL5000221MC	220pF				-	-	-	-	12	30			
*SFCDL5000331MC	330pF				-	-	-	1	16	34			
*SFCDL5000471MX	470pF	†X7R	500#	750	-	-	-	2	19	38			
SFCDL5000681MX	680pF				-	-	-	3	22	41			
*SFCDL5000102MX	1.0nF	X7R	500#	750	-	-	-	6	25	44			
SFCDL5000152MX	1.5nF				-	-	-	9	29	48			
*SFCDL5000222MX	2.2nF				-	-	-	12	31	51			
SFCDL5000332MX	3.3nF				-	-	-	15	35	54			
*SFCDL5000472MX	4.7nF				-	-	1	18	39	57			
SFCDL5000682MX	6.8nF				-	-	2	21	41	60			
*SFCDL5000103MX	10nF				-	-	4	23	43	63			
*SFCDL5000153MX	15nF				-	-	7	27	46	66			
*SFCDL5000223MX	22nF				-	-	10	30	48	68			
SFCDL5000333MX	33nF				-	-	13	34	50	70			
*SFCDL5000473MX	47nF				-	-	1	17	37	51	>70		
SFCDL5000683MX	68nF				-	-	2	20	40	55	>70		
SFCDL5000104MX	100nF				-	-	4	22	44	60	>70		
SFCDL5000154MX	150nF				-	-	7	25	47	62	>70		
*SFCDL2000224MX	220nF				-	200	500	-	10	29	49	66	>70
SFCDL1000334MX	330nF				-	100	250	-	13	33	52	68	>70
*SFCDL1000474MX	470nF				1			16	35	55	>70	>70	
SFCDL0500684MX	680nF				-	50	125	2	19	38	58	>70	>70

Also rated for operation at 115Vac 400Hz. Self heating will occur - evaluation in situ recommended. * Recommended values. † Also available in COG/NPO.

Ordering Information - SFCDL range

SF	C	D	L	500	0101	M	C	O
Type	Case style	Thread	Electrical configuration	Voltage (dc)	Capacitance in picofarads (pF)	Tolerance	Dielectric	Nuts & Washers
Syfer Filter	6.35mm Hex Head	12-32 UNEF	L = L-C Filter	050 = 50V 100 = 100V 200 = 200V 500 = 500V	First digit is 0. Second and third digits are significant figures of capacitance code. The fourth digit is number of zeros following Example: 0101 = 100pF 0332 = 3300pF	M = ±20% Z = -20+80%	C = COG/NPO X = X7R	O = Without 1 = With

Note: The addition of a 4-digit numerical suffix code can be used to denote changes to the standard part. Options include for example: change of finish / alternative voltage rating / non-standard intermediate capacitance values / test requirements. Please refer specific requests to the factory.

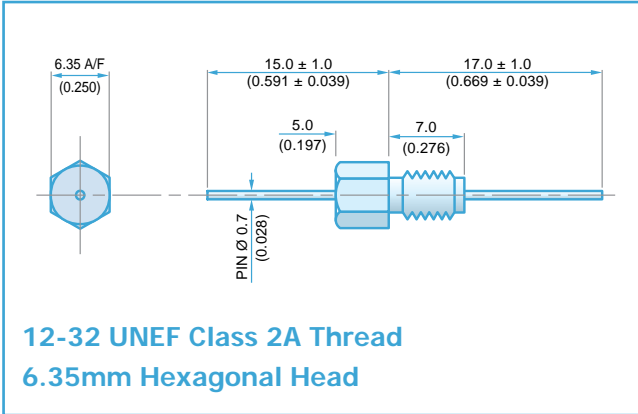

Electrical Details

Electrical Configuration	PI Filter
Capacitance Measurement	@ 1000hr Point
Current Rating	10A
Insulation Resistance (IR)	10GΩ or 1000ΩF
Temperature Rating	-55°C to +125°C
Ferrite Inductance (Typical)	250nH

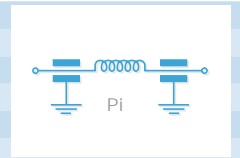

Mechanical Details

Head Diameter	6.35mm (0.250")
Nut A/F	7.92mm (0.312")
Washer Diameter	9.40mm (0.370")
Mounting Torque	0.6Nm (5.31lbf in) max. if using nut 0.3Nm (2.65lbf in) max. into tapped hole
Mounting Hole Diameter	5.7mm ± 0.1 (0.224" ± 0.004")
Max. Panel Thickness	3.9mm (0.154")
Weight (Typical)	1.8g (0.06oz)
Finish	Silver plate on copper undercoat

Product Code	Capacitance (±20%) UOS	Dielectric	Rated Voltage (Vdc)	DWV (Vdc)	Typical No-Load Insertion Loss (dB)									
					0.01MHz	0.1MHz	1MHz	10MHz	100MHz	1GHz				
*SFCDP5000200ZC	20pF -20% / +80%	COG/NPO	500#	750					1	11				
SFCDP5000300ZC	30pF -20% / +80%								2	15				
SFCDP5000440ZC	44pF -20% / +80%								3	19				
SFCDP5000660ZC	66pF -20% / +80%								4	23				
*SFCDP5000940ZC	94pF -20% / +80%								6	29				
*SFCDP500136PMC	136pF								8	35				
*SFCDP5000201MC	200pF								11	41				
SFCDP5000301MC	300pF							1	15	50				
*SFCDP5000441MC	440pF								2	20	57			
*SFCDP5000661MC	660pF								3	25	65			
*SFCDP5000941MX	940pF	†X7R				5	31	68						
SFCDP5001N36MX	1.36nF	†X7R				7	37	>70						
*SFCDP5000202MX	2nF	X7R	500#	750				10	44	>70				
SFCDP5000302MX	3nF								13	51	>70			
*SFCDP5000442MX	4.4nF									1	17	59	>70	
SFCDP5000662MX	6.6nF									2	21	64	>70	
*SFCDP5000942MX	9.4nF									4	27	68	>70	
SFCDP50013N6MX	13.6nF									6	34	>70	>70	
*SFCDP5000203MX	20nF									9	40	>70	>70	
*SFCDP5000303MX	30nF										12	48	>70	>70
*SFCDP5000443MX	44nF									1	14	54	>70	>70
SFCDP5000663MX	66nF									2	17	63	>70	>70
*SFCDP2000943MX	94nF		200	500			4	18	68	>70	>70			
SFCDP200136NMX	136nF						8	25	>70	>70	>70			
*SFCDP1000204MX	200nF		100	250			10	27	>70	>70	>70			
*SFCDP0500304MX	300nF		50	125			13	30	>70	>70	>70			

Also rated for operation at 115Vac 400Hz. Self heating will occur - evaluation in situ recommended. * Recommended values. † Also available in COG/NPO.

Ordering Information - SFCDP range

SF	C	D	P	200	0943	M	X	O
Type	Case style	Thread	Electrical configuration	Voltage (dc)	Capacitance in picofarads (pF)	Tolerance	Dielectric	Nuts & Washers
Syfer Filter	6.35mm Hex Head	12-32 UNEF	PI = Pi Filter	050 = 50V 100 = 100V 200 = 200V 500 = 500V	First digit is 0. Second and third digits are significant figures of capacitance code. The fourth digit is number of zeros following Example: 0201 = 200pF 0943 = 9400pF	M = ±20% Z = -20+80%	C = COG/NPO X = X7R	O = Without 1 = With

Note: The addition of a 4-digit numerical suffix code can be used to denote changes to the standard part. Options include for example: change of finish / alternative voltage rating / non-standard intermediate capacitance values / test requirements. Please refer specific requests to the factory.

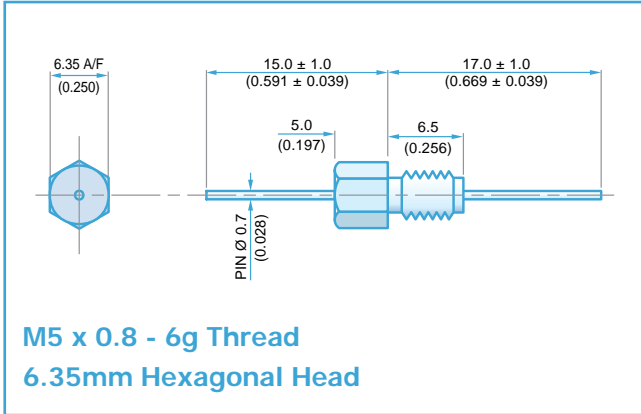

Electrical Details

Electrical Configuration	C Filter	
Capacitance Measurement	@ 1000hr Point	
Current Rating	10A	
Insulation Resistance (IR)	10GΩ or 1000ΩF	
Temperature Rating	-55°C to +125°C	
Ferrite Inductance (Typical)	Not Applicable	

Mechanical Details

Head Diameter	6.35mm (0.250")
Nut A/F	6.0mm (0.236")
Washer Diameter	9.1mm (0.358")
Mounting Torque	0.6Nm (5.31lbf in) max. if using nut 0.3Nm (2.65lbf in) max. into tapped hole
Mounting Hole Diameter	5.2mm ± 0.1 (0.205" ± 0.004")
Max. Panel Thickness	3.4mm (0.134")
Weight (Typical)	1.8g (0.06oz)
Finish	Silver plate on copper undercoat

Product Code	Capacitance (±20%) UOS	Dielectric	Rated Voltage (Vdc)	DWV (Vdc)	Typical No-Load Insertion Loss (dB)							
					0.01MHz	0.1MHz	1MHz	10MHz	100MHz	1GHz		
*SFCMC5000100ZC	10pF -20% / +80%	COG/NPO	500#	750						4		
SFCMC5000150ZC	15pF -20% / +80%										7	
SFCMC5000220ZC	22pF -20% / +80%										10	
SFCMC5000330ZC	33pF -20% / +80%										12	
*SFCMC5000470ZC	47pF -20% / +80%										1	15
*SFCMC5000680MC	68pF										2	18
*SFCMC5000101MC	100pF										4	22
SFCMC5000151MC	150pF										7	25
*SFCMC5000221MC	220pF										10	29
*SFCMC5000331MC	330pF										13	33
*SFCMC5000471MX	470pF	†X7R							1	16	35	
SFCMC5000681MX	680pF								2	19	36	
*SFCMC5000102MX	1.0nF	X7R							4	23	41	
SFCMC5000152MX	1.5nF								7	26	45	
*SFCMC5000222MX	2.2nF								10	30	50	
SFCMC5000332MX	3.3nF								13	33	52	
*SFCMC5000472MX	4.7nF							1	16	36	55	
SFCMC5000682MX	6.8nF							2	19	39	57	
*SFCMC5000103MX	10nF							4	22	41	60	
*SFCMC5000153MX	15nF							7	25	44	62	
*SFCMC5000223MX	22nF					10	29	46	65			
SFCMC5000333MX	33nF					13	33	48	68			
*SFCMC5000473MX	47nF					1	16	35	50	70		
SFCMC5000683MX	68nF					2	19	39	54	>70		
SFCMC5000104MX	100nF					4	22	41	57	>70		
SFCMC5000154MX	150nF					7	25	45	60	>70		
*SFCMC2000224MX	220nF			200	500		10	29	49	62	>70	
SFCMC1000334MX	330nF			100	250		13	33	52	66	>70	
*SFCMC1000474MX	470nF					1	16	35	55	68	>70	
SFCMC0500684MX	680nF					50	125	2	19	38	58	70

Also rated for operation at 115Vac 400Hz. Self heating will occur - evaluation in situ recommended. * Recommended values. † Also available in COG/NPO.

Ordering Information - SFCMC range

SF	C	M	C	500	0101	M	C	O
Type	Case style	Thread	Electrical configuration	Voltage (dc)	Capacitance in picofarads (pF)	Tolerance	Dielectric	Nuts & Washers
Syfer Filter	6.35mm A/F	M5	C = C Filter	050 = 50V 100 = 100V 200 = 200V 500 = 500V	First digit is 0. Second and third digits are significant figures of capacitance code. The fourth digit is number of zeros following Example: 0101 = 100pF 0332 = 3300pF	M = ±20% Z = -20+80%	C = COG/NPO X = X7R	O = Without 1 = With

Note: The addition of a 4-digit numerical suffix code can be used to denote changes to the standard part. Options include for example: change of finish / alternative voltage rating / non-standard intermediate capacitance values / test requirements. Please refer specific requests to the factory.

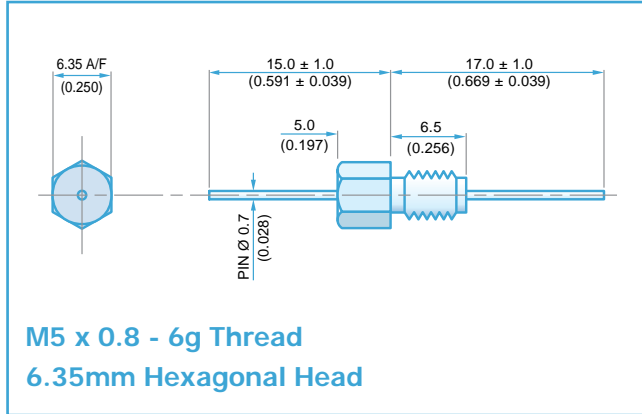
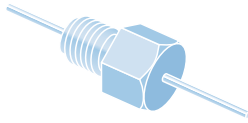

Electrical Details	
Electrical Configuration	L-C Filter
Capacitance Measurement	@ 1000hr Point
Current Rating	10A
Insulation Resistance (IR)	10GΩ or 1000ΩF
Temperature Rating	-55°C to +125°C
Ferrite Inductance (Typical)	500nH

THREAD
L-C

Mechanical Details	
Head Diameter	6.35mm (0.250")
Nut A/F	6.0mm (0.236")
Washer Diameter	9.1mm (0.358")
Mounting Torque	0.6Nm (5.31lbf in) max. if using nut 0.3Nm (2.65lbf in) max. into tapped hole
Mounting Hole Diameter	5.2mm ± 0.1 (0.205" ± 0.004")
Max. Panel Thickness	3.4mm (0.134")
Weight (Typical)	1.8g (0.06oz)
Finish	Silver plate on copper undercoat

Product Code	Capacitance (±20%) UOS	Dielectric	Rated Voltage (Vdc)	DWV (Vdc)	Typical No-Load Insertion Loss (dB)						
					0.01MHz	0.1MHz	1MHz	10MHz	100MHz	1GHz	
*SFCML5000100ZC	10pF -20% / +80%	COG/NPO	500#	750	-	-	-	-	-	6	
SFCML5000150ZC	15pF -20% / +80%				-	-	-	-	-	9	
SFCML5000220ZC	22pF -20% / +80%				-	-	-	-	-	12	
SFCML5000330ZC	33pF -20% / +80%				-	-	-	-	1	15	
*SFCML5000470ZC	47pF -20% / +80%				-	-	-	-	2	19	
*SFCML5000680MC	68pF				-	-	-	-	4	20	
*SFCML5000101MC	100pF				-	-	-	-	7	24	
SFCML5000151MC	150pF				-	-	-	-	10	27	
*SFCML5000221MC	220pF				-	-	-	-	12	30	
*SFCML5000331MC	330pF				-	-	-	1	16	34	
*SFCML5000471MX	470pF	†X7R			-	-	-	2	19	38	
SFCML5000681MX	680pF				-	-	-	3	22	41	
*SFCML5000102MX	1.0nF	X7R			-	-	-	6	25	44	
SFCML5000152MX	1.5nF				-	-	-	9	29	48	
*SFCML5000222MX	2.2nF				-	-	-	12	31	51	
SFCML5000332MX	3.3nF				-	-	-	15	35	54	
*SFCML5000472MX	4.7nF				-	-	1	18	39	57	
SFCML5000682MX	6.8nF				-	-	2	21	41	60	
*SFCML5000103MX	10nF				-	-	4	23	43	63	
*SFCML5000153MX	15nF				-	-	7	27	46	66	
*SFCML5000223MX	22nF				-	-	10	30	48	68	
SFCML5000333MX	33nF				-	-	13	34	50	70	
*SFCML5000473MX	47nF				-	1	17	37	51	>70	
SFCML5000683MX	68nF				-	2	20	40	55	>70	
*SFCML5000104MX	100nF				-	4	22	44	60	>70	
SFCML5000154MX	150nF				-	7	25	47	62	>70	
*SFCML2000224MX	220nF				-	10	29	49	66	>70	
SFCML1000334MX	330nF				-	13	33	53	68	>70	
*SFCML1000474MX	470nF				-	16	35	56	>70	>70	
SFCML0500684MX	680nF				-	19	38	58	>70	>70	
				200	500	-	10	29	49	66	>70
				100	250	-	13	33	53	68	>70
					1	16	35	56	>70	>70	
			50	125	2	19	38	58	>70	>70	

Also rated for operation at 115Vac 400Hz. Self-heating will occur - evaluation in situ recommended. * Recommended values. † Also available in COG/NPO.

Ordering Information - SFCML range

SF	C	M	L	500	0101	M	C	O
Type	Case style	Thread	Electrical configuration	Voltage (dc)	Capacitance in picofarads (pF)	Tolerance	Dielectric	Nuts & Washers
Syfer Filter	6.35mm A/F	M5	L = L-C Filter	050 = 50Vdc 100 = 100Vdc 200 = 200Vdc 500 = 500Vdc	First digit is 0. Second and third digits are significant figures of capacitance code. The fourth digit is number of zeros following Example: 0101 = 100pF 0332 = 3300pF	M = ±20% Z = -20+80%	C = COG/NPO X = X7R	O = Without 1 = With

Note: The addition of a 4-digit numerical suffix code can be used to denote changes to the standard part. Options include for example: change of finish / alternative voltage rating / non-standard intermediate capacitance values / test requirements. Please refer specific requests to the factory.

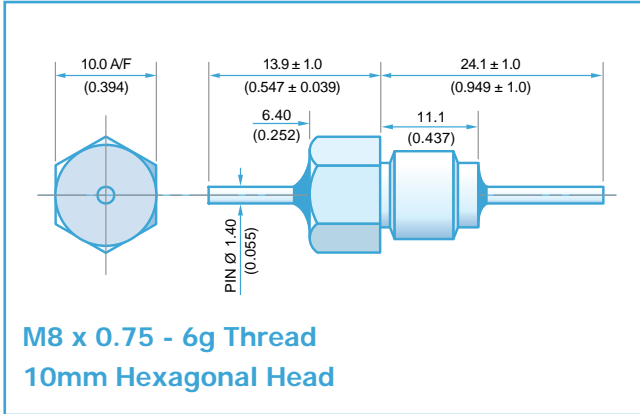
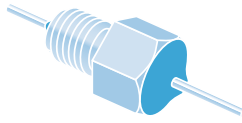

Electrical Details	
Electrical Configuration	Pi Filter
Capacitance Measurement	@ 1000hr Point
Current Rating	20A
Insulation Resistance (IR)	10GΩ or 1000ΩF
Temperature Rating	-55°C to +125°C
Ferrite Inductance (Typical)	1μH
Mechanical Details	
Head A/F	10.0mm (0.393")
Nut A/F	10.0mm (0.393")
Washer Diameter	15.1mm (0.594") Washer
Mounting Torque	1.0Nm (8.5lbf in) max. if using nut 0.5Nm (4.25lbf in) max. into tapped hole
Mounting Hole Diameter	8.2mm ± 0.1 (0.323" ± 0.004")
Max. Panel Thickness	7.95mm (0.313")
Weight (Typical)	6.2g (0.22oz)
Finish	Silver plate on copper undercoat

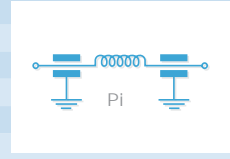

Product Code	Capacitance (±20%)	Dielectric	Rated Voltage (Vdc)	DWV (Vdc)	Typical No-Load Insertion Loss (dB)					
					0.01MHz	0.1MHz	1MHz	10MHz	100MHz	1GHz
SFDPP1K00942MX	9.4nF	X7R	1000	1.25kV	-	-	4	27	68	>70
SFDPP2000204MX	200nF		200	500	-	10	27	>70	>70	>70
SFDPP0500944MX	940nF		50	125	5	22	52	>70	>70	>70

Ordering Information - SFDPP range

SF	D	P	P	050	0944	M	X	O
Type	Case style	Thread	Electrical configuration	Voltage (dc)	Capacitance in picofarads (pF)	Tolerance	Dielectric	Nuts & Washers
Syfer Filter	10.0mm Hex Head	M8	P = Pi Filter	050 = 50V 200 = 200V 1K0 = 1kV	First digit is 0. Second and third digits are significant figures of capacitance code. The fourth digit is number of zeros following Example: 0101 = 100pF 0332 = 3300pF	M = ±20%	X = X7R	0 = Without 3 = With

Note: The addition of a 4-digit numerical suffix code can be used to denote changes to the standard part. Options include for example: change of finish / alternative voltage rating / non-standard intermediate capacitance values / test requirements. Please refer specific requests to the factory.

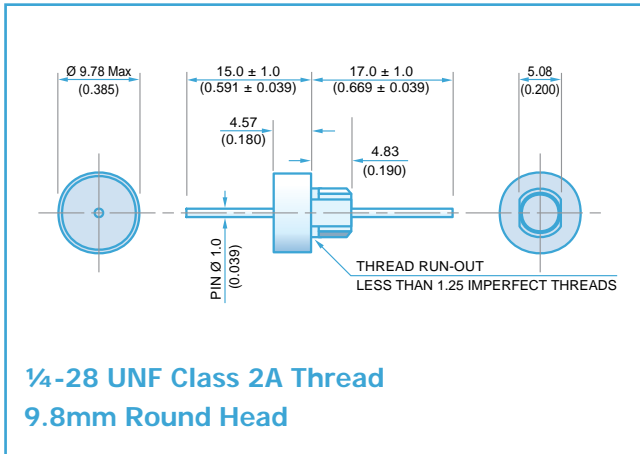

Electrical Details

Electrical Configuration	C Filter	
Capacitance Measurement	@ 1000hr Point	
Current Rating	15A	
Insulation Resistance (IR)	10GΩ or 1000ΩF	
Temperature Rating	-55°C to +125°C	
Ferrite Inductance (Typical)	Not Applicable	

Mechanical Details

Head Diameter	9.8mm (0.386")
Nut A/F	7.92mm (0.312")
Washer Diameter	11.35mm (0.447")
Mounting Torque	0.9Nm (7.97lbf in) max.
Mounting Hole Diameter	
Max. Panel Thickness	2.3mm (0.091")
Weight (Typical)	3.0g (0.11oz)
Finish ** (see notes below)	Silver plate on copper undercoat

Product Code	Capacitance (±20%)	Dielectric	Rated Voltage (Vdc)	DWV (Vdc)	Typical No-Load Insertion Loss (dB)							
					0.01MHz	0.1MHz	1MHz	10MHz	100MHz	1GHz		
SFJGC3K00101MC	100pF	COG/NPO	3kV#	3.6kV	-	-	-	-	4	22		
SFJGC3K00151MC	150pF				-	-	-	-	7	25		
SFJGC3K00221MC	220pF				-	-	-	-	10	29		
SFJGC2K00331MC	330pF				-	-	-	-	13	33		
SFJGC2K00471MC	470pF				-	-	-	1	16	35		
SFJGC2K00681MC	680pF				-	-	-	2	19	39		
SFJGC2K00102MC	1.0nF		X7R	2kV#	2.4kV	-	-	-	4	23	41	
SFJGC2K00152MX	1.5nF					-	-	-	7	26	45	
SFJGC2K00222MX	2.2nF					-	-	-	10	30	50	
*SFJGC2K00332MX	3.3nF					-	-	-	13	33	52	
SFJGC2K00472MX	4.7nF					-	-	1	16	36	55	
*SFJGC2K00682MX	6.8nF					-	-	2	19	39	57	
SFJGC2K00103MX	10nF	1kV#		1.2kV	1.2kV	-	-	4	22	41	60	
SFJGC1K00153MX	15nF					-	-	7	25	44	62	
SFJGC1K00223MX	22nF					-	-	10	29	46	65	
*SFJGC1K00333MX	33nF					-	-	13	33	48	68	
SFJGC1K00473MX	47nF					-	1	16	35	50	70	
*SFJGC1K00683MX	68nF					-	2	19	39	54	>70	
SFJGC5000104MX	100nF			500#	750	750	-	4	22	41	57	>70
*SFJGC5000154MX	150nF						-	7	25	45	60	>70
SFJGC5000224MX	220nF						-	10	29	49	62	>70
*SFJGC5000334MX	330nF						-	13	33	52	66	>70
SFJGC5000474MX	470nF						1	16	35	55	68	>70
SFJGC3000684MX	680nF						2	19	38	58	70	>70
*SFJGC2000105MX	1.0µF	200	500	500	4	22	41	61	>70	>70		
*SFJGC1000155MX	1.5µF				7	25	45	64	>70	>70		
*SFJGC1000225MX	2.2µF				10	29	48	66	>70	>70		
SFJGC0500335MX	3.3µF	50	125	125	14	34	52	70	>70	>70		

Also rated for operation at 115Vac 400Hz. Self-heating will occur - evaluation in situ recommended. * Recommended values.

Ordering Information - SFJGC range Note: Ordering code can have up to 4 additional digits on the end to denote special requirements

SF	J	G	C	050	0335	M	X	1
Type	Case style	Thread	Electrical configuration	Voltage (dc)	Capacitance in picofarads (pF)	Tolerance	Dielectric	Nuts & Washers
Syfer Filter	9.78mm Max Dia.	¼-28 UNF 5.08mm A/F	C = C Filter	050 = 50V 100 = 100V 200 = 200V 300 = 300V 500 = 500V 1K0 = 1kV 2K0 = 2kV 3K0 = 3kV	First digit is 0. Second and third digits are significant figures of capacitance code. The fourth digit is number of zeros following Example: 0101 = 100pF 0332 = 3300pF	M = ±20%	C = COG/NPO X = X7R	1 = Nut & Wavy Washer 3 = Nut & Toothed Lockwasher

Note: The addition of a 4-digit numerical suffix code can be used to denote changes to the standard part. Options include for example: change of pin length / custom body dimensions or threads / alternative voltage rating / non-standard intermediate capacitance values / test requirements. ** Standard Option 90Sn/10Pb plating finish on all metalwork (body, pin, nut and wavy washer) specified by suffix code /0100. Please refer specific requests to the factory.

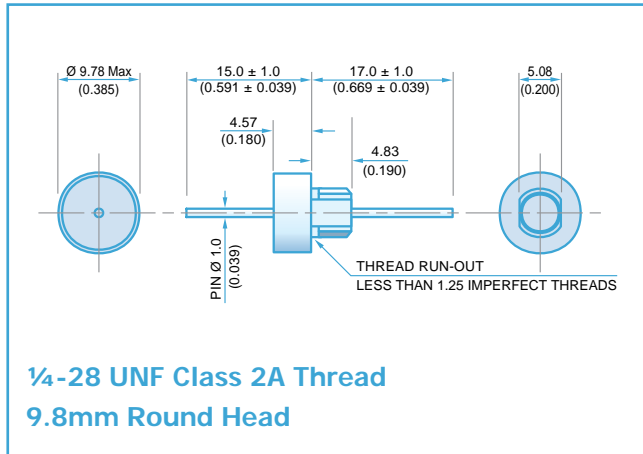

Electrical Details

Electrical Configuration	L-C Filter	
Capacitance Measurement	@ 1000hr Point	
Current Rating	15A	
Insulation Resistance (IR)	10GΩ or 1000ΩF	
Temperature Rating	-55°C to +125°C	
Ferrite Inductance (Typical)	500nH @ 1MHz	

Mechanical Details

Head Diameter	9.8mm (0.386")
Nut A/F	7.92mm (0.312")
Washer Diameter	11.35mm (0.447")
Mounting Torque	0.9Nm (7.97lbf in) max.
Mounting Hole Diameter	
Max. Panel Thickness	2.3mm (0.091")
Weight (Typical)	3.0g (0.11oz)
Finish ** (see notes below)	Silver plate on copper undercoat

Product Code	Capacitance (±20%)	Dielectric	Rated Voltage (dc)	DWV (dc)	Typical No-Load Insertion Loss (dB)						
					0.01MHz	0.1MHz	1MHz	10MHz	100MHz	1GHz	
SFJGL3K00101MC	100pF	COG/NPO	3kV#	3.6kV					7	24	
SFJGL3K00151MC	150pF							10	27		
SFJGL3K00221MC	220pF							12	30		
SFJGL2K00331MC	330pF						1	16	34		
SFJGL2K00471MC	470pF						2	19	38		
SFJGL2K00681MC	680pF						3	22	41		
SFJGL2K00102MC	1.0nF	X7R	2kV#	2.4kV				6	25	44	
SFJGL2K00152MX	1.5nF						9	29	48		
SFJGL2K00222MX	2.2nF						12	31	51		
*SFJGL2K00332MX	3.3nF						15	35	54		
SFJGL2K00472MX	4.7nF					1	18	39	57		
*SFJGL2K00682MX	6.8nF					2	21	41	60		
*SFJGL2K00103MX	10nF			4	23	43	63				
SFJGL1K00153MX	15nF			7	27	46	66				
SFJGL1K00223MX	22nF			10	30	48	68				
*SFJGL1K00333MX	33nF			13	34	50	70				
SFJGL1K00473MX	47nF			1	17	37	51	>70			
*SFJGL1K00683MX	68nF			2	20	40	55	>70			
SFJGL5000104MX	100nF			4	22	44	60	>70			
*SFJGL5000154MX	150nF			7	25	47	62	>70			
SFJGL5000224MX	220nF			10	29	49	66	>70			
*SFJGL5000334MX	330nF			13	33	53	68	>70			
SFJGL5000474MX	470nF			500	750	1	16	35	56	70	>70
SFJGL3000684MX	680nF			300	600	2	19	38	58	>70	>70
*SFJGL2000105MX	1.0µF			200	500	4	22	41	61	>70	>70
*SFJGL1000155MX	1.5µF			100	250	7	25	45	64	>70	>70
*SFJGL1000225MX	2.2µF		10			29	48	66	>70	>70	
*SFJGL0500335MX	3.3µF		50			125	14	34	52	70	>70

Also rated for operation at 115Vac 400Hz. Self-heating will occur - evaluation in situ recommended. * Recommended values.

Ordering Information - SFJGL range Note: Ordering code can have up to 4 additional digits on the end to denote special requirements

SF	J	G	L	050	0335	M	X	1
Type	Case style	Thread	Electrical configuration	Voltage (dc)	Capacitance in picofarads (pF)	Tolerance	Dielectric	Nuts & Washers
Syfer Filter	9.78mm Max Dia.	¼-28 UNF 5.08mm A/F	L = L-C Filter	050 = 50V 100 = 100V 200 = 200V 300 = 300V 500 = 500V 1K0 = 1kV 2K0 = 2kV 3K0 = 3kV	First digit is 0. Second and third digits are significant figures of capacitance code. The fourth digit is number of zeros following Example: 0101 = 100pF 0332 = 3300pF	M = ±20%	C = COG/NPO X = X7R	1 = Nut & Wavy Washer 3 = Nut & Toothed Lockwasher

Note: The addition of a 4-digit numerical suffix code can be used to denote changes to the standard part. Options include for example: change of pin length / custom body dimensions or threads / alternative voltage rating / non-standard intermediate capacitance values / test requirements. ** Standard Option 90Sn/10Pb plating finish on all metalwork (body, pin, nut and wavy washer) specified by suffix code /0100. Please refer specific requests to the factory.

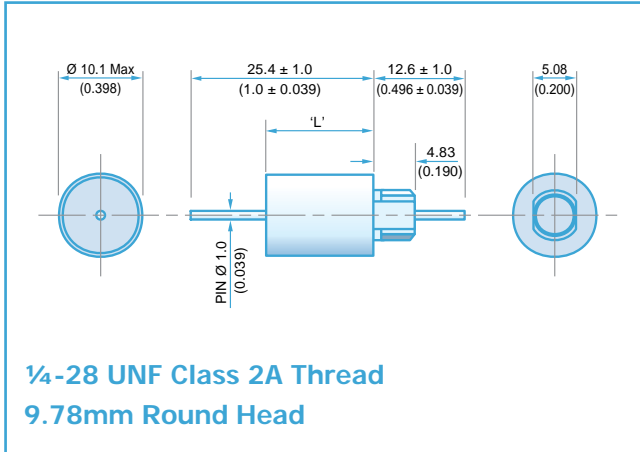
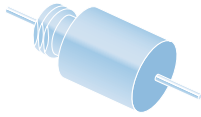

Electrical Details

Electrical Configuration	Pi Filter
Capacitance Measurement	@ 1000hr Point
Current Rating	15A
Insulation Resistance (IR)	10GΩ or 1000ΩF
Temperature Rating	-55°C to +125°C
Ferrite Inductance (Typical)	2.5µH @ 1MHz

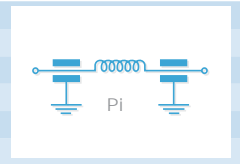

Mechanical Details

Head Diameter	9.8mm (0.386")
Nut A/F	7.92mm (0.312")
Washer Diameter	11.35mm (0.447")
Mounting Torque	0.9Nm (7.97lbf in) max.
Mounting Hole Diameter	6.7mm (0.264") O.D. 5.3mm (0.208") A/F
Max. Panel Thickness	2.3mm (0.091")
Weight (Typical)	3.0g (0.11oz)
Finish	Silver plate on copper undercoat

Product Code	Capacitance (±20%)	Dielectric	Rated Voltage (Vdc)	DWV (Vdc)	L (mm) ["]	Typical No-Load Insertion Loss (dB)								
						0.01MHz	0.1MHz	1MHz	10MHz	100MHz	1GHz			
SFJGP2K00661MC	660pF	COG/NPO	2kV#	2.4kV	17.78 [0.7]				3	25	65			
SFJGP2K00941MC	940pF						5	31	68					
SFJGP2K01N36MC	1.36nF						7	37	>70					
SFJGP2K00202MC	2.0nF						10	44	>70					
SFJGP2K00302MX	3.0nF						13	51	>70					
SFJGP2K00442MX	4.4nF						1	17	59	>70				
*SFJGP2K00662MX	6.6nF						2	21	64	>70				
SFJGP2K00942MX	9.4nF						4	27	68	>70				
*SFJGP2K013N6MX	13.6nF						6	34	>70	>70				
*SFJGP2K00203MX	20nF						9	40	>70	>70				
SFJGP1K00303MX	30nF	X7R	1kV#	1.2kV	17.78 [0.7]		12	48	>70	>70				
SFJGP1K00443MX	44nF					1	14	54	>70	>70				
*SFJGP1K00663MX	66nF					2	17	63	>70	>70				
SFJGP1K00943MX	94nF					4	18	68	>70	>70				
*SFJGP1K0136NMX	136nF					8	25	>70	>70	>70				
SFJGP5000204MX	200nF				500#	750	15.24 [0.6]		10	27	>70	>70	>70	
*SFJGP5000304MX	300nF								13	30	>70	>70	>70	
SFJGP5000444MX	440nF								1	14	45	>70	>70	>70
*SFJGP5000664MX	660nF								2	17	54	>70	>70	>70
SFJGP5000944MX	940nF								4	18	63	>70	>70	>70
SFJGP3001U36MX	1.36µF	300	600	15.24 [0.6]					8	25	68	>70	>70	
*SFJGP2000205MX	2.0µF								10	27	>70	>70	>70	
*SFJGP1000305MX	3.0µF								13	30	>70	>70	>70	
*SFJGP1000445MX	4.4µF								14	45	>70	>70	>70	
SFJGP0500665MX	6.6µF	50	125	15.24 [0.6]					17	54	>70	>70	>70	

Also rated for operation at 115Vac 400Hz. Self-heating will occur - evaluation in situ recommended. * Recommended values.

Ordering Information - SFJGP range

SF	J	G	P	050	0665	M	X	1
Type	Case style	Thread	Electrical configuration	Voltage (dc)	Capacitance in picofarads (pF)	Tolerance	Dielectric	Nuts & Washers
Syfer Filter	10.1mm Max Dia.	¼-28 UNF 5.08mm A/F	P = Pi Filter	050 = 50V 100 = 100V 200 = 200V 300 = 300V 500 = 500V 1K0 = 1kV 2K0 = 2kV	First digit is 0. Second and third digits are significant figures of capacitance code. The fourth digit is number of zeros following Example: 0101 = 100pF 0332 = 3300pF	M = ±20%	C = COG/NPO X = X7R	1 = Nut & Wavy Washer 3 = Nut & Toothed Lockwasher

Note: The addition of a 4-digit numerical suffix code can be used to denote changes to the standard part. Options include for example: change of pin length / custom body dimensions or threads / alternative voltage rating / non-standard intermediate capacitance values / test requirements. Please refer specific requests to the factory.

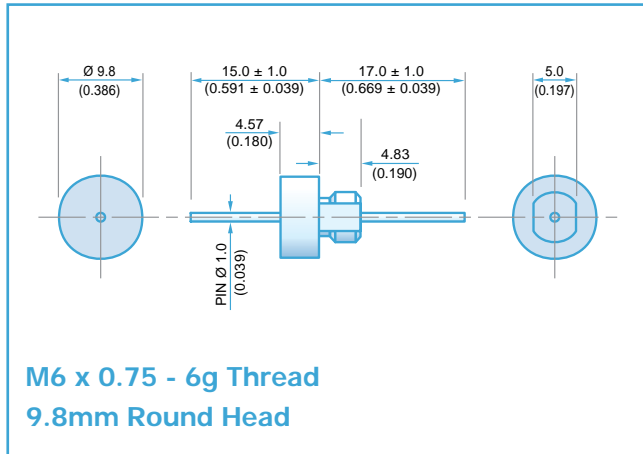

Electrical Details

Electrical Configuration	C Filter	
Capacitance Measurement	@ 1000hr Point	
Current Rating	15A	
Insulation Resistance (IR)	10GΩ or 1000ΩF	
Temperature Rating	-55°C to +125°C	
Ferrite Inductance (Typical)	Not Applicable	

Mechanical Details

Head Diameter	9.8mm (0.386")
Nut A/F	8.0mm (0.315")
Washer Diameter	11.35mm (0.447")
Mounting Torque	0.9Nm (7.97lbf in) max.
Mounting Hole Diameter	
Max. Panel Thickness	2.9mm (0.114")
Weight (Typical)	3.0g (0.11oz)
Finish	Silver plate on copper undercoat

Product Code	Capacitance (±20%)	Dielectric	Rated Voltage (Vdc)	DWV (Vdc)	Typical No-Load Insertion Loss (dB)								
					0.01MHz	0.1MHz	1MHz	10MHz	100MHz	1GHz			
SFJNC3K00101MC	100pF	COG/NPO	3kV#	3.6kV					4	22			
SFJNC3K00151MC	150pF								7	25			
SFJNC3K00221MC	220pF								10	29			
SFJNC2K00331MC	330pF								13	33			
SFJNC2K00471MC	470pF							1	16	35			
SFJNC2K00681MC	680pF							2	19	39			
SFJNC2K00102MC	1.0nF		X7R	2kV#	2.4kV				4	23	41		
SFJNC2K00152MX	1.5nF								7	26	45		
SFJNC2K00222MX	2.2nF								10	30	50		
*SFJNC2K00332MX	3.3nF								13	33	52		
SFJNC2K00472MX	4.7nF						1	16	36	55			
*SFJNC2K00682MX	6.8nF						2	19	39	57			
*SFJNC2K00103MX	10nF	X7R		1kV#	1.2kV			4	22	41	60		
SFJNC1K00153MX	15nF							7	25	44	62		
SFJNC1K00223MX	22nF							10	29	46	65		
*SFJNC1K00333MX	33nF							13	33	48	68		
SFJNC1K00473MX	47nF						1	16	35	50	70		
*SFJNC1K00683MX	68nF						2	19	39	54	>70		
SFJNC5000104MX	100nF			X7R	500#	750		4	22	41	57	>70	
*SFJNC5000154MX	150nF							7	25	45	60	>70	
SFJNC5000224MX	220nF							10	29	49	62	>70	
*SFJNC5000334MX	330nF							13	33	52	66	>70	
SFJNC5000474MX	470nF							1	16	35	55	68	>70
SFJNC3000684MX	680nF							2	19	38	58	70	>70
*SFJNC2000105MX	1.0µF	X7R	200		500	4	22	41	61	>70	>70		
*SFJNC1000155MX	1.5µF					7	25	45	64	>70	>70		
*SFJNC1000225MX	2.2µF					10	29	48	66	>70	>70		
SFJNC0500335MX	3.3µF					14	34	52	70	>70	>70		
						50	125						

Also rated for operation at 115Vac 400Hz. Self-heating will occur - evaluation in situ recommended. * Recommended values.

Ordering Information - SFJNC range

SF	J	N	C	050	0335	M	X	1
Type	Case style	Thread	Electrical configuration	Voltage (dc)	Capacitance in picofarads (pF)	Tolerance	Dielectric	Nuts & Washers
Syfer Filter	9.8mm dia.	M6	C = C Filter	050 = 50V 100 = 100V 200 = 200V 300 = 300V 500 = 500V 1K0 = 1kV 2K0 = 2kV 3K0 = 3kV	First digit is 0. Second and third digits are significant figures of capacitance code. The fourth digit is number of zeros following Example: 0101 = 100pF 0332 = 3300pF	M = ±20%	C = COG/NPO X = X7R	0 = Without 1 = With

Note: The addition of a 4-digit numerical suffix code can be used to denote changes to the standard part. Options include for example: change of pin length / custom body dimensions or threads / alternative voltage rating / non-standard intermediate capacitance values / test requirements. Please refer specific requests to the factory.

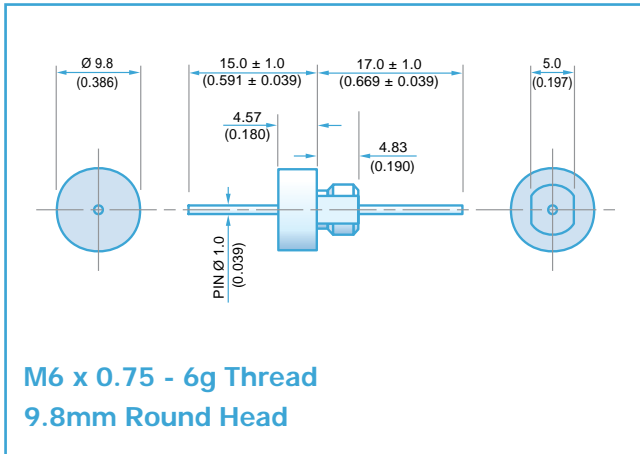

Electrical Details	
Electrical Configuration	L-C Filter
Capacitance Measurement	@ 1000hr Point
Current Rating	15A
Insulation Resistance (IR)	10GΩ or 1000ΩF
Temperature Rating	-55°C to +125°C
Ferrite Inductance (Typical)	500nH

THREAD
L-C

Mechanical Details	
Head Diameter	9.8mm (0.386")
Nut A/F	8.0mm (0.315")
Washer Diameter	11.35mm (0.447")
Mounting Torque	0.9Nm (7.97lbf in) max.
Mounting Hole Diameter	
Max. Panel Thickness	2.9mm (0.114")
Weight (Typical)	3.0g (0.11oz)
Finish	Silver plate on copper undercoat

Product Code	Capacitance (±20%)	Dielectric	Rated Voltage (Vdc)	DWV (Vdc)	Typical No-Load Insertion Loss (dB)						
					0.01MHz	0.1MHz	1MHz	10MHz	100MHz	1GHz	
SFJNL3K00101MC	100pF	COG/NPO	3kV#	3.6kV					7	24	
SFJNL3K00151MC	150pF								10	27	
SFJNL3K00221MC	220pF								12	30	
SFJNL2K00331MC	330pF							1	16	34	
SFJNL2K00471MC	470pF							2	19	38	
SFJNL2K00681MC	680pF							3	22	41	
SFJNL2K00102MC	1.0nF		X7R	2kV#	2.4kV				6	25	44
SFJNL2K00152MX	1.5nF								9	29	48
SFJNL2K00222MX	2.2nF								12	31	51
*SFJNL2K00332MX	3.3nF								15	35	54
SFJNL2K00472MX	4.7nF						1	18	39	57	
*SFJNL2K00682MX	6.8nF						2	21	41	60	
*SFJNL2K00103MX	10nF			4	23	43	63				
SFJNL1K00153MX	15nF			7	27	46	66				
SFJNL1K00223MX	22nF			10	30	48	68				
*SFJNL1K00333MX	33nF			13	34	50	70				
SFJNL1K00473MX	47nF			1	17	37	51	>70			
*SFJNL1K00683MX	68nF			2	20	40	55	>70			
SFJNL5000104MX	100nF			4	22	44	60	>70			
*SFJNL5000154MX	150nF			7	25	47	62	>70			
SFJNL5000224MX	220nF			10	29	49	66	>70			
*SFJNL5000334MX	330nF			13	33	53	68	>70			
SFJNL5000474MX	470nF			500#	750	1	16	35	56	70	>70
SFJNL3000684MX	680nF			300	600	2	19	38	58	>70	>70
*SFJNL2000105MX	1.0µF		200	500	4	22	41	61	>70	>70	
*SFJNL1000155MX	1.5µF		100	250	7	25	45	64	>70	>70	
*SFJNL1000225MX	2.2µF		100	250	10	29	48	66	>70	>70	
SFJNL0500335MX	3.3µF		50	125	14	34	52	70	>70	>70	

Also rated for operation at 115Vac 400Hz. Self-heating will occur - evaluation in situ recommended. * Recommended values.

Ordering Information - SFJNL range

SF	J	N	L	050	0335	M	X	1
Type	Case style	Thread	Electrical configuration	Voltage (dc)	Capacitance in picofarads (pF)	Tolerance	Dielectric	Nuts & Washers
Syfer Filter	9.8mm dia.	M6	L = L-C Filter	050 = 50V 100 = 100V 200 = 200V 300 = 300V 500 = 500V 1K0 = 1kV 2K0 = 2kV 3K0 = 3kV	First digit is 0. Second and third digits are significant figures of capacitance code. The fourth digit is number of zeros following Example: 0101 = 100pF 0332 = 3300pF	M = ±20%	C = COG/NPO X = X7R	0 = Without 1 = With

Note: The addition of a 4-digit numerical suffix code can be used to denote changes to the standard part. Options include for example: change of pin length / custom body dimensions or threads / alternative voltage rating / non-standard intermediate capacitance values / test requirements. Please refer specific requests to the factory.

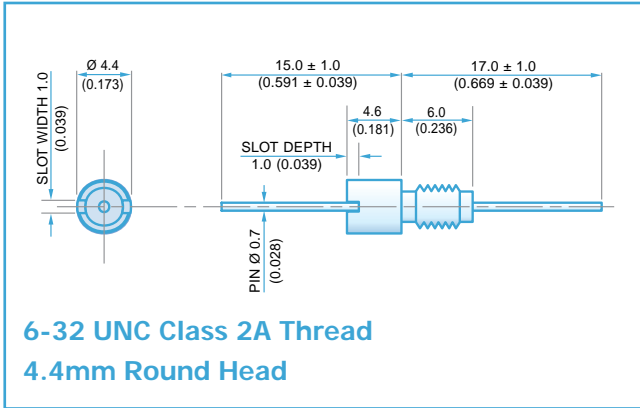
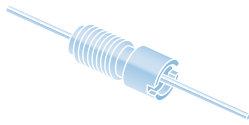

Electrical Details

Electrical Configuration	C Filter	
Capacitance Measurement	@ 1000hr Point	
Current Rating	10A	
Insulation Resistance (IR)	10GΩ or 1000ΩF	
Temperature Rating	-55°C to +125°C	
Ferrite Inductance (Typical)	Not Applicable	

Mechanical Details

Head Diameter	4.4mm (0.173")
Nut A/F	N/a. For use in tapped hole
Washer Diameter	N/a
Mounting Torque	0.15Nm (1.32lbf in) max.
Mounting Hole	6-32 UNC Class 2B
Max. Panel Thickness	N/a
Weight (Typical)	0.8g (0.03oz)
Finish	Silver plate on copper undercoat

Product Code	Capacitance (±20%) UOS	Dielectric	Rated Voltage (Vdc)	DWV (Vdc)	Typical No-Load Insertion Loss (dB)						
					0.01MHz	0.1MHz	1MHz	10MHz	100MHz	1GHz	
*SFKBC5000100ZC	10pF -20% / +80%	COG/NPO	500#	750						4	
SFKBC5000150ZC	15pF -20% / +80%										7
SFKBC5000220ZC	22pF -20% / +80%										10
SFKBC5000330ZC	33pF -20% / +80%										12
*SFKBC5000470ZC	47pF -20% / +80%									1	15
*SFKBC5000680MC	68pF									2	18
*SFKBC5000101MC	100pF									4	22
SFKBC5000151MC	150pF									7	25
*SFKBC5000221MC	220pF									10	29
*SFKBC5000331MC	330pF									13	33
*SFKBC5000471MX	470pF	†X7R	500#	500				1	16	35	
SFKBC5000681MX	680pF		500#					2	19	36	
*SFKBC5000102MX	1.0nF	X7R	500#					4	23	41	
SFKBC5000152MX	1.5nF				500#				7	26	45
*SFKBC5000222MX	2.2nF				500#				10	30	50
SFKBC5000332MX	3.3nF				500#				13	33	52
*SFKBC5000472MX	4.7nF				500#			1	16	36	55
SFKBC5000682MX	6.8nF				500#			2	19	39	57
*SFKBC5000103MX	10nF				500#			4	22	41	60
*SFKBC5000153MX	15nF				500#			7	25	44	62
*SFKBC5000223MX	22nF			500#			10	29	46	65	
SFKBC5000333MX	33nF			500#			13	33	48	68	
*SFKBC2000473MX	47nF		200	500		1	16	35	50	70	
SFKBC2000683MX	68.0nF		200			2	19	39	54	>70	
*SFKBC1000104MX	100nF		100		250		4	22	41	57	>70
*SFKBC0500154MX	150nF		50	125		7	25	45	60	>70	

Also rated for operation at 115Vac 400Hz. Self-heating will occur – evaluation in situ recommended. * Recommended values. † Also available in COG/NPO.

Ordering Information - SFKBC range

SF	K	B	C	500	0101	M	C	O
Type	Case style	Thread	Electrical configuration	Voltage (dc)	Capacitance in picofarads (pF)	Tolerance	Dielectric	Nuts & Washers
Syfer Filter	4.4mm O.D.	6-32 UNC	C = C Filter	050 = 50V 100 = 100V 200 = 200V 500 = 500V	First digit is 0. Second and third digits are significant figures of capacitance code. The fourth digit is number of zeros following Example: 0101 = 100pF 0332 = 3300pF	M = ±20% Z = -20+80%	C = COG/NPO X = X7R	0 = Without

Note: Installation tool available on request
Note: The addition of a 4-digit numerical suffix code can be used to denote changes to the standard part. Options include for example: change of finish / alternative voltage rating / non-standard intermediate capacitance values / test requirements. Please refer specific requests to the factory.

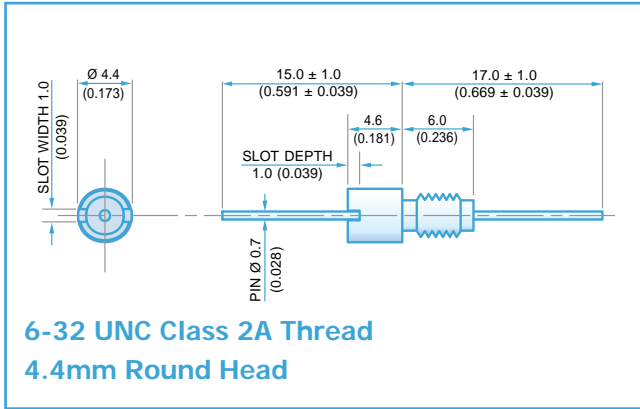
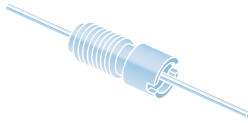

Electrical Details

Electrical Configuration	L-C Filter
Capacitance Measurement	@ 1000hr Point
Current Rating	10A
Insulation Resistance (IR)	10GΩ or 1000ΩF
Temperature Rating	-55°C to +125°C
Ferrite Inductance (Typical)	50nH

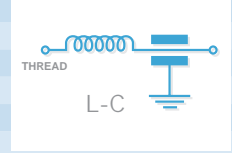

Mechanical Details

Head Diameter	4.4mm (0.173")
Nut A/F	N/a. For use in tapped hole
Washer Diameter	N/a
Mounting Torque	0.15Nm (1.32lbf in) max.
Mounting Hole	6-32 UNC Class 2B
Max. Panel Thickness	N/a
Weight (Typical)	0.8g (0.03oz)
Finish	Silver plate on copper undercoat

Product Code	Capacitance (±20%) UOS	Dielectric	Rated Voltage (Vdc)	DWV (Vdc)	Typical No-Load Insertion Loss (dB)						
					0.01MHz	0.1MHz	1MHz	10MHz	100MHz	1GHz	
* SFKBL5000100ZC	10pF -20% / +80%	COG/NPO	500#	750						6	
SFKBL5000150ZC	15pF -20% / +80%		500#		9						
SFKBL5000220ZC	22pF -20% / +80%		500#		12						
SFKBL5000330ZC	33pF -20% / +80%		500#				1	15			
* SFKBL5000470ZC	47pF -20% / +80%		500#				2	19			
* SFKBL5000680MC	68pF		500#				4	20			
* SFKBL5000101MC	100pF		500#				7	24			
SFKBL5000151MC	150pF		500#				10	27			
* SFKBL5000221MC	220pF		500#				12	30			
* SFKBL5000331MC	330pF		500#						1	16	34
* SFKBL5000471MX	470pF	†X7R	500#				2	19	38		
SFKBL5000681MX	680pF		500#			3	22	41			
* SFKBL5000102MX	1.0nF	X7R	500#				6	25	44		
SFKBL5000152MX	1.5nF		500#			9	29	48			
* SFKBL5000222MX	2.2nF		500#					12	31	51	
SFKBL5000332MX	3.3nF		500#					15	35	54	
* SFKBL5000472MX	4.7nF		500#					1	18	39	57
SFKBL5000682MX	6.8nF		500#					2	21	41	60
* SFKBL5000103MX	10nF		500#					4	23	43	63
* SFKBL5000153MX	15nF		500#					7	27	46	66
* SFKBL5000223MX	22nF		500#					10	30	48	68
SFKBL5000333MX	33nF		500#						13	34	50
* SFKBL2000473MX	47nF		200	500			1	17	37	51	>70
SFKBL2000683MX	68nF		200				2	20	40	55	>70
*SFKBL1000104MX	100nF		100		250			4	22	44	60
*SFKBL0500154MX	150nF		50	125			7	25	47	62	>70

Also rated for operation at 115Vac 400Hz. Self heating will occur – evaluation in situ recommended. * Recommended values. † Also available in COG/NPO.

Ordering Information - SFKBL range

SF	K	B	L	500	0101	M	C	O
Type	Case style	Thread	Electrical configuration	Voltage (dc)	Capacitance in picofarads (pF)	Tolerance	Dielectric	Nuts & Washers
Syfer Filter	4.4mm O.D.	6-32 UNC	L = L-C Filter	050 = 50V 100 = 100V 200 = 200V 500 = 500V	First digit is 0. Second and third digits are significant figures of capacitance code. The fourth digit is number of zeros following Example: 0101 = 100pF 0332 = 3300pF	M = ±20% Z = -20+80%	C = COG/NPO X = X7R	O = Without

Note: Installation tool available on request
 Note: The addition of a 4-digit numerical suffix code can be used to denote changes to the standard part.
 Options include for example: change of finish / alternative voltage rating / non-standard intermediate capacitance values / test requirements. Please refer specific requests to the factory.

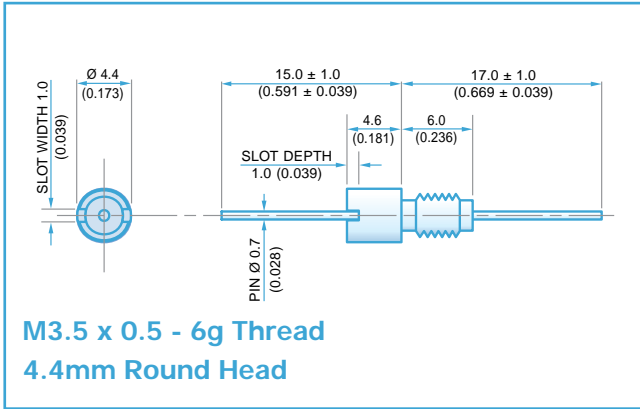
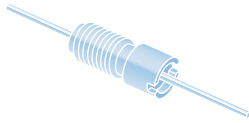

Electrical Details	
Electrical Configuration	C Filter
Capacitance Measurement	@ 1000hr Point
Current Rating	10A
Insulation Resistance (IR)	10GΩ or 1000ΩF
Temperature Rating	-55°C to +125°C
Ferrite Inductance (Typical)	Not Applicable

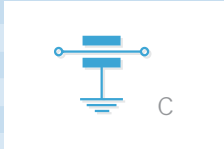

Mechanical Details	
Head Diameter	4.4mm (0.173")
Nut A/F	N/a. For use in tapped hole
Washer Diameter	N/a
Mounting Torque	0.18Nm (1.59lbf in) max.
Mounting Hole	M3.5 x 0.5 - 6h
Max. Panel Thickness	N/a
Weight (Typical)	0.8g (0.03oz)
Finish	Silver plate on copper undercoat

Product Code	Capacitance (±20%) UOS	Dielectric	Rated Voltage (Vdc)	DWV (Vdc)	Typical No-Load Insertion Loss (dB)							
					0.01MHz	0.1MHz	1MHz	10MHz	100MHz	1GHz		
*SFKCC5000100ZC	10pF -20% / +80%	COG/NPO	500#	750						4		
SFKCC5000150ZC	15pF -20% / +80%											7
SFKCC5000220ZC	22pF -20% / +80%											10
SFKCC5000330ZC	33pF -20% / +80%											12
*SFKCC5000470ZC	47pF -20% / +80%										1	15
*SFKCC5000680MC	68pF										2	18
*SFKCC5000101MC	100pF										4	22
SFKCC5000151MC	150pF										7	25
*SFKCC5000221MC	220pF										10	29
*SFKCC5000331MC	330pF										13	33
*SFKCC5000471MX	470pF	†X7R	500#	750				1	16	35		
SFKCC5000681MX	680pF								2	19	36	
*SFKCC5000102MX	1.0nF	X7R							4	23	41	
SFKCC5000152MX	1.5nF								7	26	45	
*SFKCC5000222MX	2.2nF								10	30	50	
SFKCC5000332MX	3.3nF								13	33	52	
*SFKCC5000472MX	4.7nF								1	16	36	55
SFKCC5000682MX	6.8nF								2	19	39	57
*SFKCC5000103MX	10nF								4	22	41	60
*SFKCC5000153MX	15nF								7	25	44	62
*SFKCC5000223MX	22nF						10	29	46	65		
SFKCC5000333MX	33nF						13	33	48	68		
*SFKCC2000473MX	47nF		200	500	1	16	35	50	70			
SFKCC2000683MX	68nF				2	19	39	54	>70			
*SFKCC1000104MX	100nF				4	22	41	57	>70			
* SFKCC0500154MX	150nF		50	125	7	25	45	60	>70			

Also rated for operation at 115Vac 400Hz. Self heating will occur – evaluation in situ recommended. * Recommended values. † Also available in COG/NPO.

Ordering Information - SFKCC range

SF	K	K	C	500	0101	M	C	O
Type	Case style	Thread	Electrical configuration	Voltage (dc)	Capacitance in picofarads (pF)	Tolerance	Dielectric	Nuts & Washers
Syfer Filter	4.4mm O.D.	M3.5	C = C Filter	050 = 50V 100 = 100V 200 = 200V 500 = 500V	First digit is 0. Second and third digits are significant figures of capacitance code. The fourth digit is number of zeros following Example: 0101 = 100pF 0332 = 3300pF	M = ±20% Z = -20+80%	C = COG/NPO X = X7R	O = Without

Note: Installation tool available on request
Note: The addition of a 4-digit numerical suffix code can be used to denote changes to the standard part. Options include for example: change of finish / alternative voltage rating / non-standard intermediate capacitance values / test requirements. Please refer specific requests to the factory.

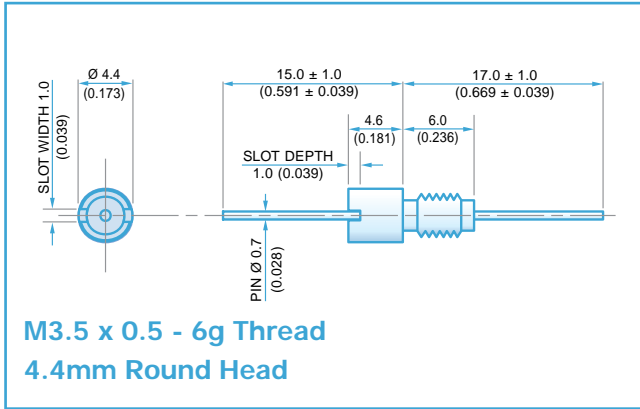
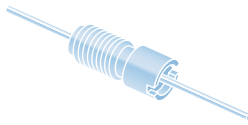

Electrical Details

Electrical Configuration	L-C Filter
Capacitance Measurement	@ 1000hr Point
Current Rating	10A
Insulation Resistance (IR)	10GΩ or 1000ΩF
Temperature Rating	-55°C to +125°C
Ferrite Inductance (Typical)	50nH

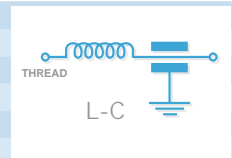

Mechanical Details

Head Diameter	4.4mm (0.173")
Nut A/F	N/A. For use in tapped hole
Washer Diameter	N/A
Mounting Torque	0.18Nm (1.59lbf in) max.
Mounting Hole	M3.5 x 0.6 - 6h
Max. Panel Thickness	N/
Weight (Typical)	0.8g (0.03oz)
Finish	Silver plate on copper undercoat

Product Code	Capacitance (±20%) UOS	Dielectric	Rated Voltage (Vdc)	DWV (Vdc)	Typical No-Load Insertion Loss (dB)						
					0.01MHz	0.1MHz	1MHz	10MHz	100MHz	1GHz	
*SFKKL5000100ZC	10pF -20% / +80%	COG/NPO	500#	750						6	
SFKKL5000150ZC	15pF -20% / +80%										9
SFKKL5000220ZC	22pF -20% / +80%										12
SFKKL5000330ZC	33pF -20% / +80%										15
*SFKKL5000470ZC	47pF -20% / +80%										19
*SFKKL5000680MC	68pF										20
*SFKKL5000101MC	100pF										24
SFKKL5000151MC	150pF										27
*SFKKL5000221MC	220pF										30
*SFKKL5000331MC	330pF										34
*SFKKL5000471MX	470pF	†X7R						38			
SFKKL5000681MX	680pF							41			
*SFKKL5000102MX	1.0nF	X7R	200	500					44		
SFKKL5000152MX	1.5nF										48
*SFKKL5000222MX	2.2nF										51
SFKKL5000332MX	3.3nF										54
*SFKKL5000472MX	4.7nF										57
SFKKL5000682MX	6.8nF										60
*SFKKL5000103MX	10nF										63
*SFKKL5000153MX	15nF										66
*SFKKL5000223MX	22nF										68
SFKKL5000333MX	33nF										70
*SFKKL2000473MX	47nF		100	250	1	17	37	51	>70		
SFKKL2000683MX	68nF		50	125	2	20	40	55	>70		
*SFKKL1000104MX	100nF				4	22	44	60	>70		
*SFKKL0500154MX	150nF				7	25	47	62	>70		

Also rated for operation at 115Vac 400Hz. Self-heating will occur – evaluation in situ recommended. * Recommended values. † Also available in COG/NPO.

Ordering Information - SFKKL range

SF	K	K	L	500	0101	M	C	O
Type	Case style	Thread	Electrical configuration	Voltage (dc)	Capacitance in picofarads (pF)	Tolerance	Dielectric	Nuts & Washers
Syfer Filter	4.4mm O.D.	M3.5	L = L-C Filter	050 = 50V 100 = 100V 200 = 200V 500 = 500V	First digit is 0. Second and third digits are significant figures of capacitance code. The fourth digit is number of zeros following Example: 0101 = 100pF 0332 = 3300pF	M = ±20% Z = -20+80%	C = COG/NPO X = X7R	O = Without

Note: Installation tool available on request

Note: The addition of a 4-digit numerical suffix code can be used to denote changes to the standard part.

Options include for example: change of finish / alternative voltage rating / non-standard intermediate capacitance values / test requirements. Please refer specific requests to the factory.

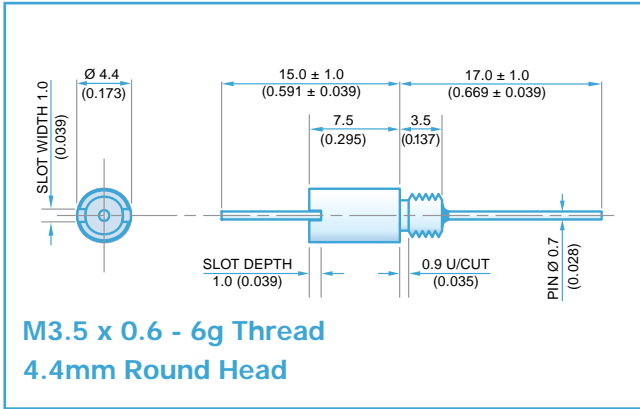
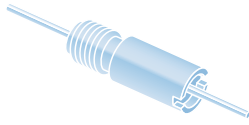

Electrical Details	
Electrical Configuration	T Filter
Capacitance Measurement	@ 1000hr Point
Current Rating	10A
Insulation Resistance (IR)	10GΩ or 1000ΩF
Temperature Rating	-55°C to +125°C
Ferrite Inductance (Typical)	100nH

Mechanical Details	
Head Diameter	4.4mm (0.173")
Nut A/F	N/A. For use in tapped hole
Washer Diameter	N/A
Mounting Torque	0.18Nm (1.59lbf in) max.
Mounting Hole	M3.5 x 0.5 - 6h
Max. Panel Thickness	N/A
Weight (Typical)	0.8g (0.03oz)
Finish	Silver plate on copper undercoat

Product Code	Capacitance (±20%) UOS	Dielectric	Rated Voltage (Vdc)	DWV (Vdc)	Typical No-Load Insertion Loss (dB)									
					0.01MHz	0.1MHz	1MHz	10MHz	100MHz	1GHz				
*SFKKT5000100ZC	10pF -20% / +80%	COG/NPO	500#	750						9				
SFKKT5000150ZC	15pF -20% / +80%											11		
SFKKT5000220ZC	22pF -20% / +80%										1	14		
SFKKT5000330ZC	33pF -20% / +80%										2	18		
*SFKKT5000470ZC	47pF -20% / +80%										4	20		
*SFKKT5000680MC	68pF										6	23		
*SFKKT5000101MC	100pF										9	27		
SFKKT5000151MC	150pF										12	30		
*SFKKT5000221MC	220pF										15	33		
*SFKKT5000331MC	330pF													
*SFKKT5000471MX	470pF	†X7R					1	19	36					
SFKKT5000681MX	680pF						2	21	40					
*SFKKT5000102MX	1.0nF	X7R	200	500				4	24	43				
SFKKT5000152MX	1.5nF									7	28	47		
*SFKKT5000222MX	2.2nF									10	30	50		
SFKKT5000332MX	3.3nF									13	34	53		
*SFKKT5000472MX	4.7nF									17	38	57		
SFKKT5000682MX	6.8nF									19	40	59		
*SFKKT5000103MX	10nF									1	23	43	63	
*SFKKT5000153MX	15nF									4	26	45	66	
*SFKKT5000223MX	22nF									7	29	47	68	
SFKKT5000333MX	33nF									10	33	49	70	
*SFKKT2000473MX	47nF									14	36	50	>70	
SFKKT2000683MX	68nF									1	17	39	52	>70
*SFKKT1000104MX	100nF									2	20	42	57	>70
*SFKKT0500154MX	150nF									4	22	46	62	>70
										7	25	49	68	>70

Also rated for operation at 115Vac 400Hz. Self-heating will occur – evaluation in situ recommended. * Recommended values. † Also available in COG/NPO.

Ordering Information - SFKKT range

SF	K	K	T	500	0101	M	C	O
Type	Case style	Thread	Electrical configuration	Voltage (dc)	Capacitance in picofarads (pF)	Tolerance	Dielectric	Nuts & Washers
Syfer Filter	4.4mm O.D.	M3.5	T = T Filter	050 = 50V 100 = 100V 200 = 200V 500 = 500V	First digit is 0. Second and third digits are significant figures of capacitance code. The fourth digit is number of zeros following Example: 0101 = 100pF 0332 = 3300pF	M = ±20% Z = -20+80%	C = COG/NPO X = X7R	O = Without

Note: The addition of a 4-digit numerical suffix code can be used to denote changes to the standard part. Options include for example: change of finish / alternative voltage rating / non-standard intermediate capacitance values / test requirements. Please refer specific requests to the factory. * Mounting tool available.

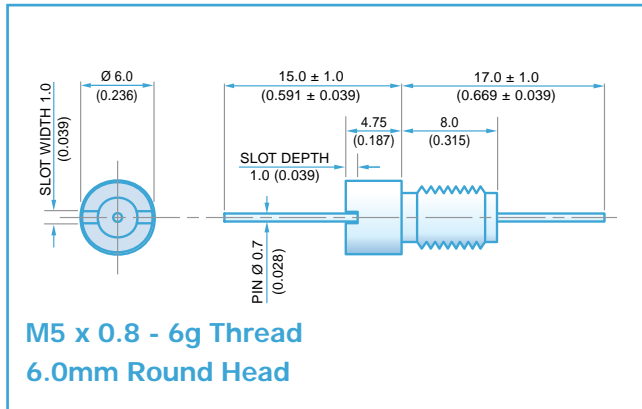
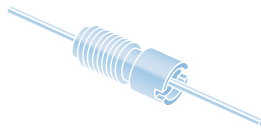

Electrical Details

Electrical Configuration	C Filter
Capacitance Measurement	@ 1000hr Point
Current Rating	10A
Insulation Resistance (IR)	10GΩ or 1000ΩF
Temperature Rating	-55°C to +125°C
Ferrite Inductance (Typical)	Not Applicable

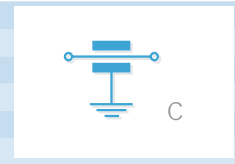

Mechanical Details

Head Diameter	6.0mm (0.236")
Nut A/F	N/A. For use in tapped hole
Washer Diameter	N/A
Mounting Torque	0.3Nm (2.65lbf in) max.
Mounting Hole	M5 x 0.8 - 6h
Max. Panel Thickness	N/A
Weight (Typical)	2.0g (0.07oz)
Finish	Silver plate on copper undercoat

Product Code	Capacitance (±20%) UOS	Dielectric	Rated Voltage (Vdc)	DWV (Vdc)	Typical No-Load Insertion Loss (dB)							
					0.01MHz	0.1MHz	1MHz	10MHz	100MHz	1GHz		
*SFLMC5000100ZC	10pF -20% / +80%	COG/NPO	500#	750						4		
SFLMC5000150ZC	15pF -20% / +80%										7	
SFLMC5000220ZC	22pF -20% / +80%										10	
SFLMC5000330ZC	33pF -20% / +80%										12	
*SFLMC5000470ZC	47pF -20% / +80%										1	15
*SFLMC5000680MC	68pF										2	18
*SFLMC5000101MC	100pF										4	22
SFLMC5000151MC	150pF										7	25
*SFLMC5000221MC	220pF										10	29
*SFLMC5000331MC	330pF										13	33
*SFLMC5000471MX	470pF	†X7R	500#	750				1	16	35		
SFLMC5000681MX	680pF								2	19	36	
*SFLMC5000102MX	1.0nF	X7R							4	23	41	
SFLMC5000152MX	1.5nF								7	26	45	
*SFLMC5000222MX	2.2nF								10	30	50	
SFLMC5000332MX	3.3nF								13	33	52	
*SFLMC5000472MX	4.7nF								1	16	36	55
SFLMC5000682MX	6.8nF								2	19	39	57
*SFLMC5000103MX	10nF								4	22	41	60
*SFLMC5000153MX	15nF								7	25	44	62
*SFLMC5000223MX	22nF						10	29	46	65		
SFLMC5000333MX	33nF						13	33	48	68		
*SFLMC2000473MX	47nF		200	500		1	16	35	50	70		
SFLMC2000683MX	68nF							2	19	39	54	>70
*SFLMC1000104MX	100nF				100	250		4	22	41	57	>70
*SFLMC0500154MX	150nF		50	125		7	25	45	60	>70		

Also rated for operation at 115Vac 400Hz. Self-heating will occur – evaluation in situ recommended. * Recommended values. † Also available in COG/NPO.

Ordering Information - SFLMC range

SF	L	M	C	500	0101	M	C	O
Type	Case style	Thread	Electrical configuration	Voltage (dc)	Capacitance in picofarads (pF)	Tolerance	Dielectric	Nuts & Washers
Syfer Filter	6.0mm O.D.	M5	C = C Filter	050 = 50V 100 = 100V 200 = 200V 500 = 500V	First digit is 0. Second and third digits are significant figures of capacitance code. The fourth digit is number of zeros following Example: 0101 = 100pF 0332 = 3300pF	M = ±20% Z = -20+80%	C = COG/NPO X = X7R	O = Without

Note: Installation tool available on request

Note: The addition of a 4-digit numerical suffix code can be used to denote changes to the standard part.

Options include for example: change of finish / alternative voltage rating / non-standard intermediate capacitance values / test requirements. Please refer specific requests to the factory.

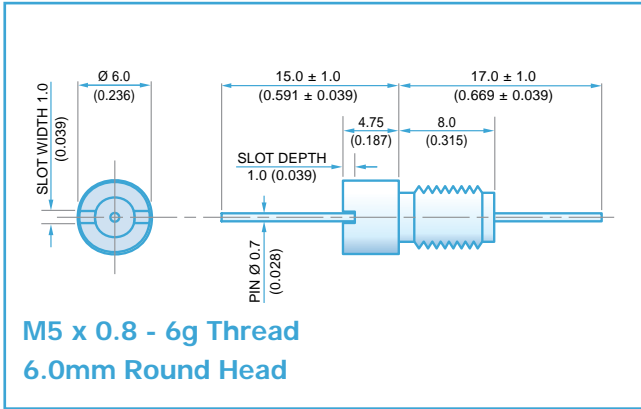
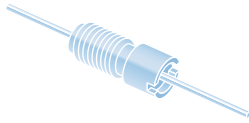

Electrical Details	
Electrical Configuration	L-C Filter
Capacitance Measurement	@ 1000hr Point
Current Rating	10A
Insulation Resistance (IR)	10GΩ or 1000ΩF
Temperature Rating	-55°C to +125°C
Ferrite Inductance (Typical)	500nH

Mechanical Details	
Head Diameter	6.0mm (0.236")
Nut A/F	N/A. For use in tapped hole
Washer Diameter	N/A
Mounting Torque	0.3Nm (2.65lbf in) max.
Mounting Hole	M5 x 0.8 - 6h
Max. Panel Thickness	N/A
Weight (Typical)	2.0g (0.07oz)
Finish	Silver plate on copper undercoat

Product Code	Capacitance (±20%) UOS	Dielectric	Rated Voltage (Vdc)	DWV (Vdc)	Typical No-Load Insertion Loss (dB)								
					0.01MHz	0.1MHz	1MHz	10MHz	100MHz	1GHz			
*SFLML5000100ZC	10pF -20% / +80%	COG/NPO	500#	750						6			
SFLML5000150ZC	15pF -20% / +80%											9	
SFLML5000220ZC	22pF -20% / +80%											12	
SFLML5000330ZC	33pF -20% / +80%										1	15	
*SFLML5000470ZC	47pF -20% / +80%										2	19	
*SFLML5000680MC	68pF										4	20	
*SFLML5000101MC	100pF										7	24	
SFLML5000151MC	150pF										10	27	
*SFLML5000221MC	220pF										12	30	
*SFLML5000331MC	330pF												
*SFLML5000471MX	470pF	†X7R					1	16	34				
SFLML5000681MX	680pF						2	19	38				
*SFLML5000102MX	1.0nF	X7R	200	500				3	22	41			
SFLML5000152MX	1.5nF									6	25	44	
*SFLML5000222MX	2.2nF									9	29	48	
SFLML5000332MX	3.3nF									12	31	51	
*SFLML5000472MX	4.7nF									15	35	54	
SFLML5000682MX	6.8nF									1	18	39	57
*SFLML5000103MX	10nF									2	21	41	60
*SFLML5000153MX	15nF									4	23	43	63
*SFLML5000223MX	22nF									7	27	46	66
SFLML5000333MX	33nF									10	30	48	68
*SFLML2000473MX	47nF						13	34	50	70			
SFLML2000683MX	68nF		100	250			1	17	37	51	>70		
*SFLML1000104MX	100nF		50	125			2	20	40	55	>70		
*SFLML0500154MX	150nF						4	22	44	60	>70		
							7	25	47	62	>70		

Also rated for operation at 115Vac 400Hz. Self-heating will occur – evaluation in situ recommended. * Recommended values. † Also available in COG/NPO.

Ordering Information - SFLML range

SF	L	M	L	500	0101	M	C	O
Type	Case style	Thread	Electrical configuration	Voltage (dc)	Capacitance in picofarads (pF)	Tolerance	Dielectric	Nuts & Washers
Syfer Filter	6.0mm O.D.	M5	L = L-C Filter	050 = 50V 100 = 100V 200 = 200V 500 = 500V	First digit is 0. Second and third digits are significant figures of capacitance code. The fourth digit is number of zeros following Example: 0101 = 100pF 0332 = 3300pF	M = ±20% Z = -20+80%	C = COG/NPO X = X7R	O = Without

Note: Installation tool available on request

Note: The addition of a 4-digit numerical suffix code can be used to denote changes to the standard part.

Options include for example: change of finish / alternative voltage rating / non-standard intermediate capacitance values / test requirements. Please refer specific requests to the factory.

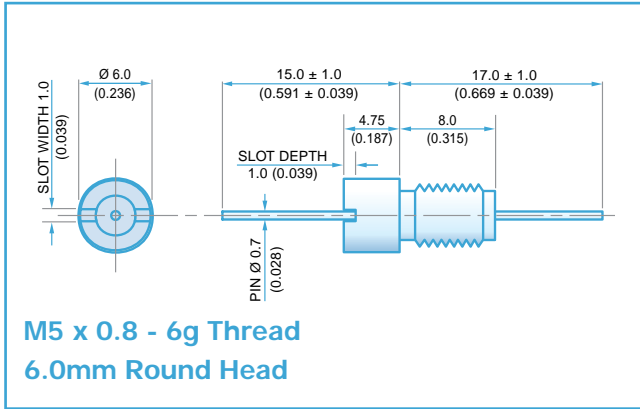
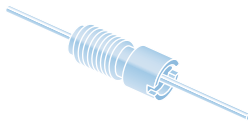

Electrical Details

Electrical Configuration	PI Filter
Capacitance Measurement	@ 1000hr Point
Current Rating	10A
Insulation Resistance (IR)	10GΩ or 1000ΩF
Temperature Rating	-55°C to +125°C
Ferrite Inductance (Typical)	250nH

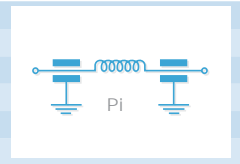

Mechanical Details

Head Diameter	6.0mm (0.236")
Nut A/F	N/A. For use in tapped hole
Washer Diameter	N/A
Mounting Torque	0.3Nm (2.65lbf in) max.
Mounting Hole	M5 x 0.8 - 6h
Max. Panel Thickness	N/A
Weight (Typical)	2.0g (0.07oz)
Finish	Silver plate on copper undercoat

Product Code	Capacitance (±20%) UOS	Dielectric	Rated Voltage (Vdc)	DWV (Vdc)	Typical No-Load Insertion Loss (dB)							
					0.01MHz	0.1MHz	1MHz	10MHz	100MHz	1GHz		
*SFLMP5000200ZC	20pF -20% / +80%	COG/NPO	500#	750					1	11		
SFLMP5000300ZC	30pF -20% / +80%										2	15
SFLMP5000440ZC	44pF -20% / +80%										3	19
SFLMP5000660ZC	66pF -20% / +80%										4	23
*SFLMP5000940ZC	94pF -20% / +80%										6	29
*SFLMP500136PMC	136pF										8	35
*SFLMP5000201MC	200pF										11	41
SFLMP5000301MC	300pF									1	15	50
*SFLMP5000441MC	440pF									2	20	57
*SFLMP5000661MC	660pF									3	25	65
*SFLMP5000941MX	940pF									5	31	68
SFLMP5001N36MX	1.36nF				†X7R					7	37	>70
*SFLMP5000202MX	2nF	X7R							10	44	>70	
SFLMP5000302MX	3nF									13	51	>70
*SFLMP5000442MX	4.4nF									1	17	59
SFLMP5000662MX	6.6nF									2	21	64
*SFLMP5000942MX	9.4nF									4	27	68
SFLMP50013N6MX	13.6nF									6	34	>70
*SFLMP5000203MX	20nF									9	40	>70
*SFLMP5000303MX	30nF									12	48	>70
*SFLMP5000443MX	44nF									1	14	54
SFLMP5000663MX	66nF									2	17	63
*SFLMP2000943MX	94nF									4	18	68
SFLMP200136NMX	136nF					200	500			8	25	>70
*SFLMP1000204MX	200nF			100	250			10	27	>70		
*SFLMP0500304MX	300nF			50	125			13	30	>70		

Also rated for operation at 115Vac 400Hz. Self-heating will occur – evaluation in situ recommended. * Recommended values. † Also available in COG/NPO.

Ordering Information - SFLMP range

SF	L	M	P	050	0304	M	X	O
Type	Case style	Thread	Electrical configuration	Voltage (dc)	Capacitance in picofarads (pF)	Tolerance	Dielectric	Nuts & Washers
Syfer Filter	6.0mm O.D.	M5	P = Pi Filter	050 = 50V 100 = 100V 200 = 200V 500 = 500V	First digit is 0. Second and third digits are significant figures of capacitance code. The fourth digit is number of zeros following Example: 0101 = 100pF 0332 = 3300pF	M = ±20% Z = -20+80%	C = COG/NPO X = X7R	O = Without

Note: Installation tool available on request

Note: The addition of a 4-digit numerical suffix code can be used to denote changes to the standard part.

Options include for example: change of finish / alternative voltage rating / non-standard intermediate capacitance values / test requirements. Please refer specific requests to the factory.

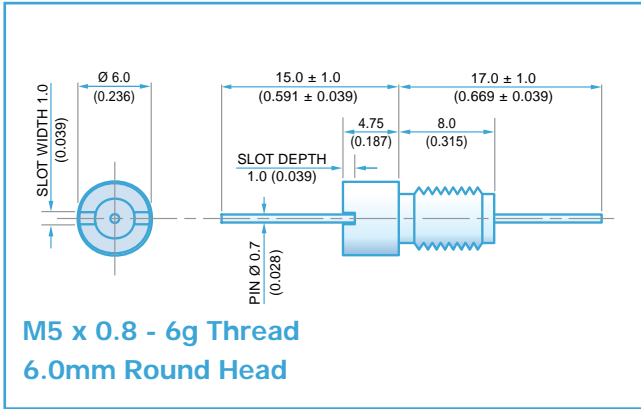
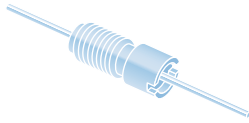

Electrical Details

Electrical Configuration	T Filter	
Capacitance Measurement	@ 1000hr Point	
Current Rating	10A	
Insulation Resistance (IR)	10GΩ or 1000ΩF	
Temperature Rating	-55°C to +125°C	
Ferrite Inductance (Typical)	450nH	

Mechanical Details

Head Diameter	6.0mm (0.236")
Nut A/F	N/a. For use in tapped hole
Washer Diameter	N/a
Mounting Torque	0.3Nm (2.65lbf in) max.
Mounting Hole	M5 x 0.8 - 6h
Max. Panel Thickness	N/a
Weight (Typical)	2.0g (0.07oz)
Finish	Silver plate on copper undercoat

Product Code	Capacitance (±20%) UOS	Dielectric	Rated Voltage (Vdc)	DWV (Vdc)	Typical No-Load Insertion Loss (dB)							
					0.01MHz	0.1MHz	1MHz	10MHz	100MHz	1GHz		
*SFLMT5000100ZC	10pF -20% / +80%	COG/NPO	500#	750						9		
SFLMT5000150ZC	15pF -20% / +80%											11
SFLMT5000220ZC	22pF -20% / +80%										1	14
SFLMT5000330ZC	33pF -20% / +80%										2	18
*SFLMT5000470ZC	47pF -20% / +80%										4	20
*SFLMT5000680MC	68pF										6	23
*SFLMT5000101MC	100pF										9	27
SFLMT5000151MC	150pF										12	30
*SFLMT5000221MC	220pF										15	33
*SFLMT5000331MC	330pF											
*SFLMT5000471MX	470pF	†X7R						1	19			
SFLMT5000681MX	680pF							2	21			
*SFLMT5000102MX	1.0nF	X7R	200	500						40		
SFLMT5000152MX	1.5nF										4	24
*SFLMT5000222MX	2.2nF										7	28
SFLMT5000332MX	3.3nF										10	30
*SFLMT5000472MX	4.7nF										13	34
SFLMT5000682MX	6.8nF										17	38
*SFLMT5000103MX	10nF										19	40
SFLMT5000153MX	15nF										23	43
*SFLMT5000223MX	22nF										1	23
SFLMT5000333MX	33nF										4	26
*SFLMT2000473MX	47nF							7	29			
*SFLMT2000683MX	68nF							10	33			
*SFLMT1000104MX	100nF							14	36			
*SFLMT0500154MX	150nF							1	17			
								2	20			
								4	22			
								7	25			
								1	17			
								2	20			
								4	22			
								7	25			
								1	17			
								2	20			
								4	22			
								7	25			
								1	17			
								2	20			
								4	22			
								7	25			

Also rated for operation at 115Vac 400Hz. Self- heating will occur – evaluation in situ recommended. * Recommended values. † Also available in COG/NPO.

Ordering Information - SFLMT range

SF	L	M	T	500	0101	M	C	O
Type	Case style	Thread	Electrical configuration	Voltage (dc)	Capacitance in picofarads (pF)	Tolerance	Dielectric	Nuts & Washers
Syfer Filter	6.0mm O.D.	M5	T = T Filter	050 = 50V 100 = 100V 200 = 200V 500 = 500V	First digit is 0. Second and third digits are significant figures of capacitance code. The fourth digit is number of zeros following Example: 0101 = 100pF 0332 = 3300pF	M = ±20% Z = -20+80%	C = COG/NPO X = X7R	0 = Without

Note: Installation tool available on request

Note: The addition of a 4-digit numerical suffix code can be used to denote changes to the standard part.

Options include for example: change of finish / alternative voltage rating / non-standard intermediate capacitance values / test requirements. Please refer specific requests to the factory.

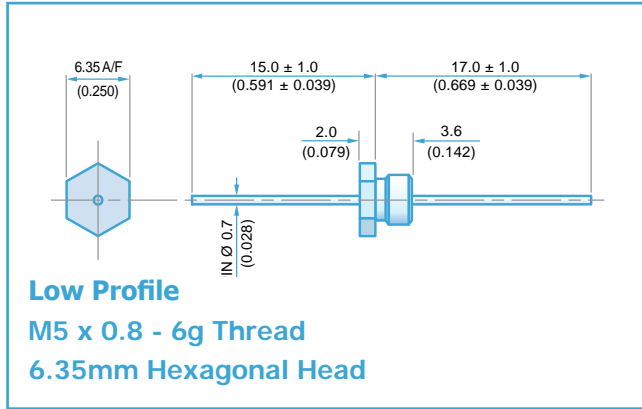

Electrical Details	
Electrical Configuration	C Filter
Capacitance Measurement	@ 1000hr Point
Current Rating	10A
Insulation Resistance (IR)	10GΩ or 1000ΩF
Temperature Rating	-55°C to +125°C
Ferrite Inductance (Typical)	Not Applicable

Mechanical Details	
Head A/F	6.35mm (0.250")
Nut A/F	N/A. For use in tapped hole
Washer Diameter	N/A
Mounting Torque	0.3Nm (2.65lbf in) max.
Mounting Hole	M5 x 0.8 - 6h
Max. Panel Thickness	N/A
Weight (Typical)	1.2g (0.04oz)
Finish	Silver plate on copper undercoat

Product Code	Capacitance (±20%) UOS	Dielectric	Rated Voltage (Vdc)	DWV (Vdc)	Typical No-Load Insertion Loss (dB)							
					0.01MHz	0.1MHz	1MHz	10MHz	100MHz	1GHz		
*SFTMC5000100ZC	10pF -20% / +80%	COG/NPO	500#	750						4		
SFTMC5000150ZC	15pF -20% / +80%											7
*SFTMC5000220ZC	22pF -20% / +80%											10
*SFTMC5000330ZC	33pF -20% / +80%											12
*SFTMC5000470ZC	47pF -20% / +80%										1	15
SFTMC5000680MC	68pF										2	18
*SFTMC5000101MC	100pF										4	22
*SFTMC5000151MC	150pF										7	25
*SFTMC5000221MX	220pF										10	29
SFTMC5000331MX	330pF										13	33
*SFTMC5000471MX	470pF				†X7R					1	16	35
SFTMC5000681MX	680pF									2	19	39
*SFTMC5000102MX	1.0nF	X7R	200	500				4	23	41		
SFTMC5000152MX	1.5nF						7	26	45			
*SFTMC5000222MX	2.2nF						10	30	50			
SFTMC5000332MX	3.3nF						13	33	52			
*SFTMC5000472MX	4.7nF						1	16	36	55		
*SFTMC5000682MX	6.8nF						2	19	39	57		
*SFTMC5000103MX	10nF						4	22	41	60		
SFTMC5000153MX	15nF						7	25	44	62		
*SFTMC5000223MX	22nF						10	29	46	65		
SFTMC5000333MX	33nF						13	33	48	68		
*SFTMC2000473MX	47nF						1	16	35	50	70	
*SFTMC2000683MX	68nF						2	19	39	54	>70	
*SFTMC1000104MX	100nF					100	250	4	22	41	57	>70
*SFTMC0500154MX	150nF					50	125	7	25	45	60	>70

Also rated for operation at 115Vac 400Hz. Self-heating will occur – evaluation in situ recommended. * Recommended values. † Also available in COG/NPO.

Ordering Information - SFTMC range

SF	T	M	C	500	0101	M	C	O
Type	Case style	Thread	Electrical configuration	Voltage (dc)	Capacitance in picofarads (pF)	Tolerance	Dielectric	Nuts & Washers
Syfer Filter	6.35mm Hex. Head Low Profile	M5	C = C Filter	050 = 50V 100 = 100V 200 = 200V 500 = 500V	First digit is 0. Second and third digits are significant figures of capacitance code. The fourth digit is number of zeros following Example: 0101 = 100pF 0332 = 3300pF	M = ±20% Z = -20+80%	C = COG/NPO X = X7R	O = Without

Note: The addition of a 4-digit numerical suffix code can be used to denote changes to the standard part. Options include for example: change of finish / alternative voltage rating / non-standard intermediate capacitance values / test requirements. Please refer specific requests to the factory.

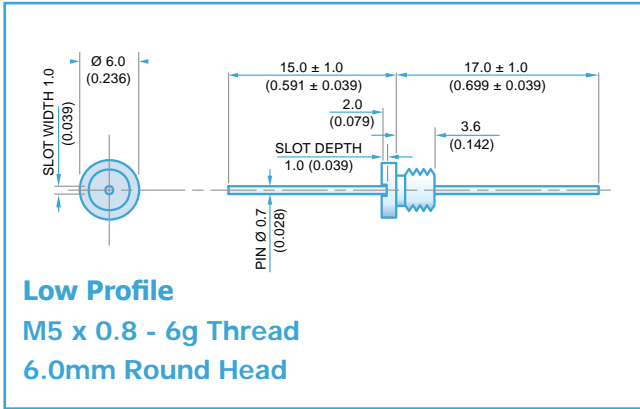

Electrical Details	
Electrical Configuration	C Filter
Capacitance Measurement	@ 1000hr Point
Current Rating	10A
Insulation Resistance (IR)	10GΩ or 1000ΩF
Temperature Rating	-55°C to +125°C
Ferrite Inductance (Typical)	Not Applicable

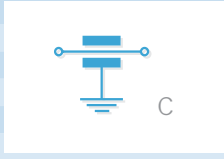

Mechanical Details	
Head Diameter	6.0mm (0.236")
Nut A/F	N/A. For use in tapped hole
Washer Diameter	N/A
Mounting Torque	0.3Nm (2.65lbf in) max.
Mounting Hole	M5 x 0.8 - 6h
Max. Panel Thickness	N/A
Weight (Typical)	1.2g (0.04oz)
Finish	Silver plate on copper undercoat

Product Code	Capacitance (±20%) UOS	Dielectric	Rated Voltage (Vdc)	DWV (Vdc)	Typical No-Load Insertion Loss (dB)								
					0.01MHz	0.1MHz	1MHz	10MHz	100MHz	1GHz			
*SFUMC5000100ZC	10pF -20% / +80%	COG/NPO	500#	750						4			
SFUMC5000150ZC	15pF -20% / +80%										7		
SFUMC5000220ZC	22pF -20% / +80%										10		
SFUMC5000330ZC	33pF -20% / +80%										12		
*SFUMC5000470ZC	47pF -20% / +80%										1	15	
*SFUMC5000680MC	68pF										2	18	
*SFUMC5000101MC	100pF										4	22	
SFUMC5000151MC	150pF										7	25	
*SFUMC5000221MC	220pF										10	29	
*SFUMC5000331MC	330pF										13	33	
*SFUMC5000471MX	470pF	†X7R					1	16	35				
SFUMC5000681MX	680pF						2	19	39				
*SFUMC5000102MX	1.0nF	X7R	200	500				4	23	41			
SFUMC5000152MX	1.5nF								7	26	45		
*SFUMC5000222MX	2.2nF									10	30	50	
SFUMC5000332MX	3.3nF									13	33	52	
*SFUMC5000472MX	4.7nF									1	16	36	55
SFUMC5000682MX	6.8nF									2	19	39	57
*SFUMC5000103MX	10nF									4	22	41	60
*SFUMC5000153MX	15nF									7	25	44	62
*SFUMC5000223MX	22nF									10	29	46	65
SFUMC5000333MX	33nF									13	33	48	68
*SFUMC2000473MX	47nF		100	250		1	16	35	50	70			
SFUMC2000683MX	68nF		50	125		2	19	39	54	>70			
*SFUMC1000104MX	100nF					4	22	41	57	>70			
*SFUMC0500154MX	150nF					7	25	45	60	>70			

Also rated for operation at 115Vac 400Hz. Self-heating will occur – evaluation in situ recommended. * Recommended values. † Also available in COG/NPO.

Ordering Information - SFUMC range

SF	U	M	C	500	0101	M	C	O
Type	Case style	Thread	Electrical configuration	Voltage (dc)	Capacitance in picofarads (pF)	Tolerance	Dielectric	Nuts & Washers
Syfer Filter	6.0mm O.D. Low Profile	M5	C = C Filter	050 = 50V 100 = 100V 200 = 200V 500 = 500V	First digit is 0. Second and third digits are significant figures of capacitance code. The fourth digit is number of zeros following Example: 0101 = 100pF 0332 = 3300pF	M = ±20% Z = -20+80%	C = COG/NPO X = X7R	O = Without

Note: Installation tool available on request
 Note: The addition of a 4-digit numerical suffix code can be used to denote changes to the standard part.
 Options include for example: change of finish / alternative voltage rating / non-standard intermediate capacitance values / test requirements. Please refer specific requests to the factory.
 * Mounting tool available.

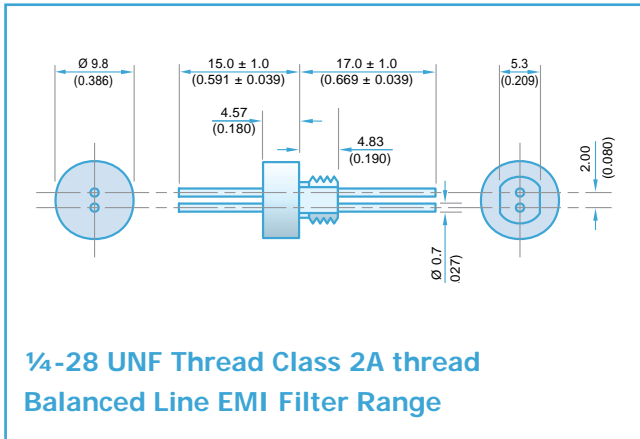
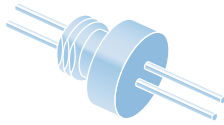

Electrical Details

Electrical Configuration	X2Y
Capacitance Measurement	@ 1000hr Point
Temperature Rating	-55°C to +125°C
Rated Voltage	200Vdc
Dielectric Withstand Voltage	500Vdc
Dielectric	X7R

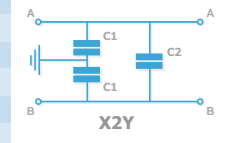

Mechanical Details

Head Diameter	9.8mm (0.386")
Nut A/F	7.92mm (0.312")
Washer Diameter	11.35mm (0.447")
Mounting Torque	0.9Nm (7.97lbf in) max.
Mounting Hole Diameter	6.7mm (0.264") O.D. 5.5mm (0.217") A/F
Max. Panel Thickness	2.3mm (0.091")
Weight (Typical)	3.0g (0.11oz)
Finish	Silver plate on copper undercoat

Product Code	Capacitance (±20%) UOS	Dielectric	Rated Voltage (Vdc)	DWV (Vdc)	Typical No-Load Insertion Loss (dB)					
					0.01MHz	0.1MHz	1MHz	10MHz	100MHz	1GHz
SFJEB2000472MX1	C1 = 4.7nF C2 = 2.35nF	X7R	200	500			1	16	36	55
SFJEB2000103MX1	C1 = 10nF C2 = 5nF						4	22	41	60
SFJEB2000223MX1	C1 = 22nF C2 = 11nF						10	29	46	65
SFJEB2000473MX1	C1 = 47nF C2 = 23.5nF					1	16	35	50	70
SFJEB2000104MX1	C1 = 100nF C2 = 50nF					4	22	41	57	>70

Ordering Information - SFJEB range

SF	J	E	B	200	0103	M	X	1
Type	Case style	Thread	Electrical configuration	Voltage (dc)	Capacitance in picofarads (pF)	Tolerance	Dielectric	Nuts & Washers
Syfer Filter	9.8mm O.D.	¼-28 UNF	Balanced Line Filter	200 = 200V	First digit is 0. Second and third digits are significant figures of capacitance code. The fourth digit is number of zeros following Example: 0472 = 4700pF 0223 = 22000pF	M = ±20% (Standard)	X = X7R	1 = With

L-C circuit optional - refer to factory

Note: The addition of a 4-digit numerical suffix code can be used to denote changes to the standard part.

Options include for example: change of pin length / custom body dimensions or threads / alternative voltage rating / non-standard intermediate capacitance values / test requirements. Please refer specific requests to the factory.

The multilayer planar array is an application specific multi capacitor array designed for use in multiway EMI filter circuits. Derived from discoidal capacitor theory, it provides capacitance between the outside perimeter and the internal through holes.

The most common use of planar arrays is as the capacitor element in filter connectors, although they are also suitable in many other applications.

Knowles' core wet manufacturing process and ceramic handling expertise allows components to be produced with mechanical precision and electrical accuracy, enabling a filter assembly to withstand the most rigorous of electrical specifications. This has resulted in Knowles' position as the manufacturer of choice for the filter connector industry. To date, Knowles have delivered in excess of 4,000 different designs of planar array.

Mechanical

With many years experience, Knowles have developed a comprehensive range of designs, including planform designs for the following connectors:

- Circular (MIL-C-38999, MIL-C-26482 and similar)
- Arinc 404 and 600
- 'D' sub
- High Density 'D' sub
- µD (MIL-C-83513)

Special custom shapes and layouts can also be accommodated. Complex shapes including internal and external radii, multiple hole diameters and alignment guides can be considered.

As a guide, Knowles can manufacture planars to a maximum of 3.18mm (0.125") thick and to a maximum of 100mm (4.0") diameter or square.

Standard termination finish is gold plate over nickel for maximum electrical and mechanical performance.

Solderless assembly/compliant spring clip

Solderless assembly of planars can be accommodated by the inclusion of compliant spring clips into the holes, allowing the array to be push fitted to through contact pins.

Knowles can supply a standard range of solder-in spring clips, or fit customer supplied compliant clips before shipping the finished array assembly.

Contract assembly and technical back-up

Having an EMI filter assembly line alongside the ceramic manufacturing area allows Knowles to offer unprecedented technical back-up and advice to planar array and discoidal customers. This can include design and handling advice and forensic analysis assistance. Knowles personnel have many years experience in the use of planar arrays, having been involved directly in the development of the technology from its inception.

Knowles are also able to offer subcontract and prototype manufacturing services to planar customers and connector companies.

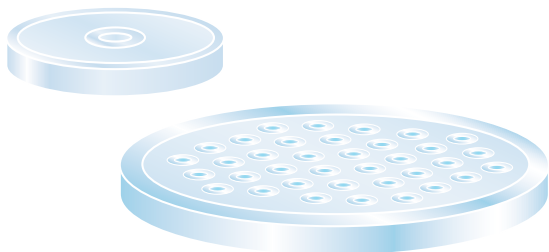
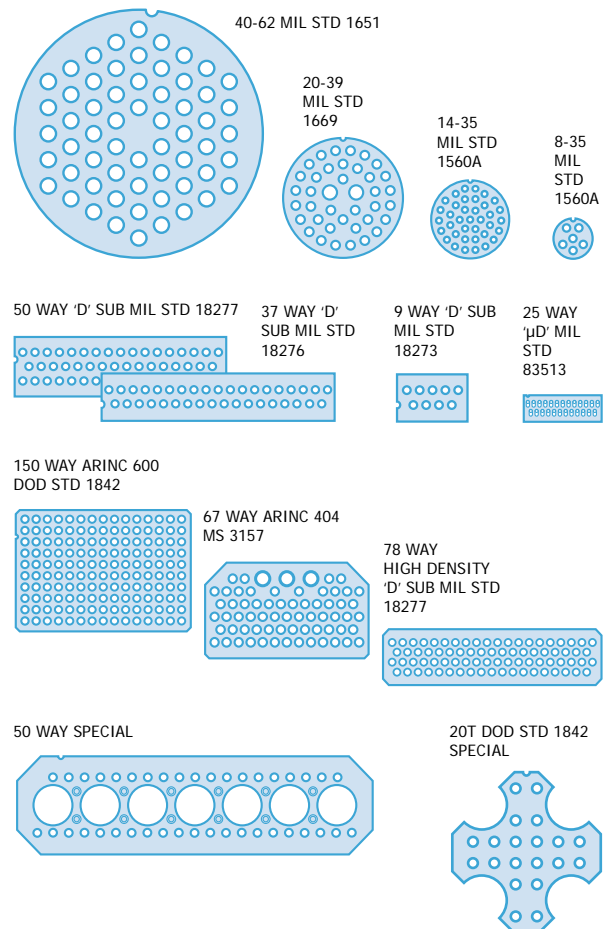
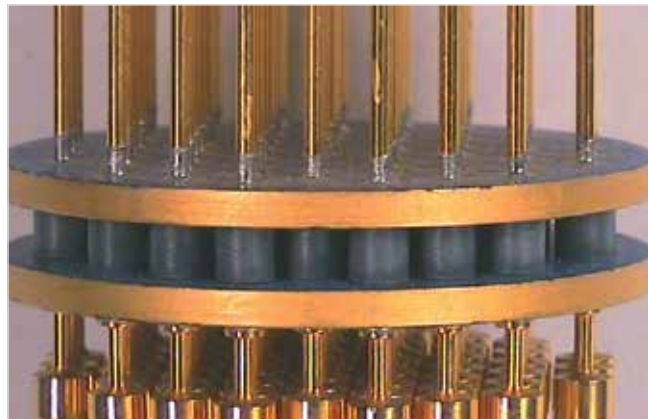
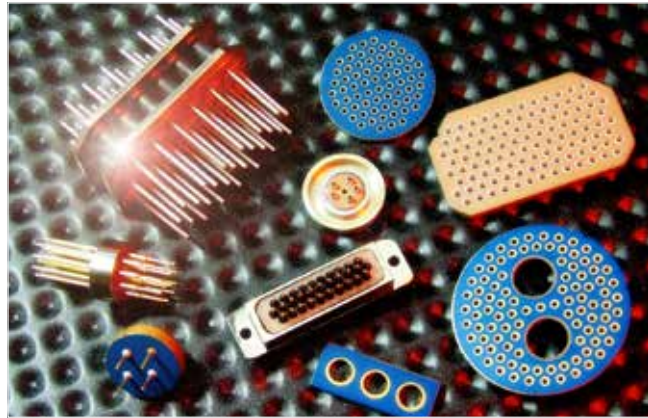

Discoidal capacitors are at the heart of many EMI filters. More robust and reliable than tubular capacitors, they offer higher capacitance options, with values up to several microfarads. In addition to standard configurations, Knowles is able to meet customers' specific drawings in terms of electrical performance and mechanical design.

Discoidal multilayer ceramic capacitors are of a configuration suitable for direct mounting into filters, onto bulkheads and hybrid circuits. Due to their geometry, they have excellent RF performance characteristics as well as very high self resonant frequencies. They are offered with a choice of COG/NPO or X7R ceramic.

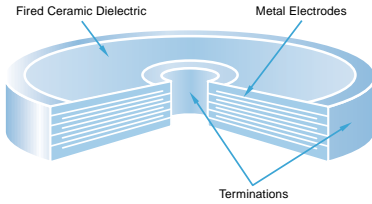

Typical capacitance vs disc size vs voltage
Based on typical hole diameter of 0.8mm, and X7R dielectric.

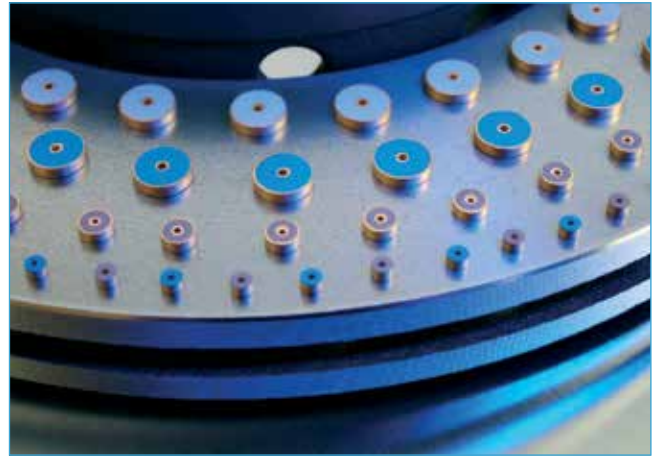
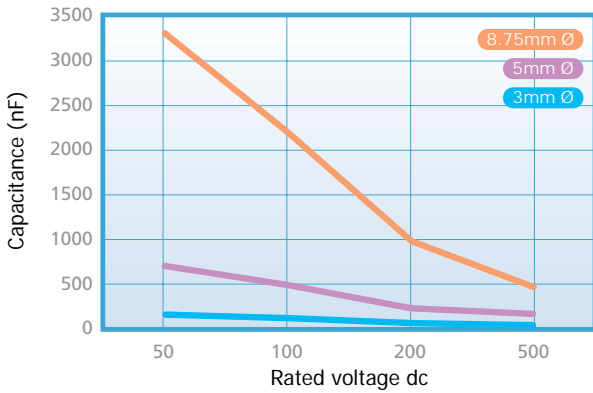

General Specification

Dielectrics:
COG/NPO, X7R

Mechanical:
Outer diameter 2.0mm minimum
Inner diameter 0.5mm minimum
Minimum wall thickness requirements apply. Refer to factory.

Capacitance range:
pF to μ F

Capacitance tolerance:
 $\pm 5\%$, $\pm 10\%$, $\pm 20\%$, $-0\% + 100\%$

Voltage:
50V to 3kVdc or higher

Operating temperature range:
 -55°C to $+125^{\circ}\text{C}$

Termination:
Gold over nickel



To reflect the unique custom nature of discoidals and planar arrays, we do not list a standard range. Please contact the sales office to discuss your specific requirements.



Electrical

- Only stable X7R and ultra stable COG/NPO dielectrics used
- Capacitance values from pF to μF
- High voltage capability - DWV (Dielectric Withstand Voltage) to 10kV
- Feedthrough low capacitance unterminated lines
- Grounded earth lines - maximum ground plane resistance specifications included
- Mix of capacitance values within planar – up to a ratio of 400:1 within individual planar possible
- Mixed capacitance lines/no cap feedthrough lines/grounded earth lines available within single planar

Quality

All planars are tested for the following:

- Capacitance
 - Dissipation factor
 - DWV (Dielectric Withstand Voltage)
 - Insulation resistance
 - Visual inspection
 - Sample solderability and dimensional check
- } 100%

100% SAM (Scanning Acoustic Microscopy) testing is offered as an option on all planars intended for more critical applications.

Graphs of typical maximum capacitance values against voltage for array thicknesses of 0.065" (1.65mm), 0.100" (2.54mm) and 0.125" (3.18mm).

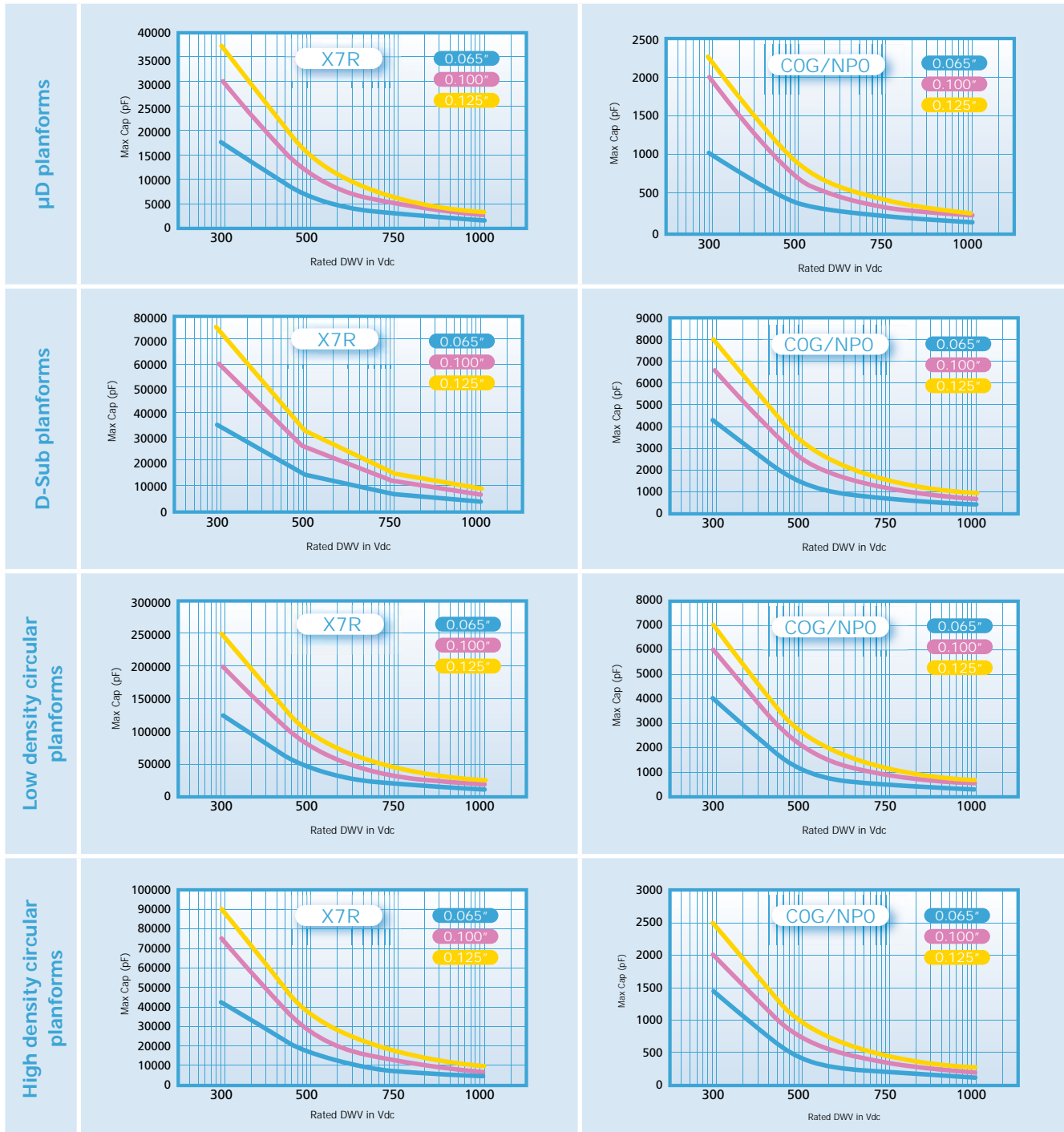

Special Filters and Assemblies

Manufacturing to customer designs or working together with the customer to develop a solution to a problem, Knowles offer the ability to modify standard filter designs or develop custom designs to suit your application.

Modifications to standard filters

Special mechanical outline

Typical examples:

- Lead lengths to suit
- Special thread options – e.g. M5 x 0.5 – 6g
- Special lead forms – e.g. headed pin/threaded contact
- Larger pin diameters
- Special body or pin finishes

Special electrical testing

Typical examples:

- Special test voltages – e.g. 500Vac 50Hz DWV test
- Special capacitance values
- 100% burn-in
- Higher current ratings possible

Multiway filter assemblies

From a simple panel fitted with our single line discrete filters to a complex custom designed Pi filter assembly, we offer a full design and manufacture service. Assemblies can be based around discoidal capacitors for maximum flexibility or planar arrays for optimum space utilisation.

As an extension to our planar array range, we can offer soldered-in spring retaining clips for easy assembly into difficult applications such as hermetic sealed connectors and our extensive experience with filter connectors allows us to offer subcontract manufacturing to this industry sector.



- **Example 1** - 4 way 22nF C section planar based filter assembly. DWV 2500Vdc, 100% tested. Supplied to sensor manufacturer for installation into commercial aerospace application.
- **Example 2** - 85 way 1800pF L-C section planar based filter assembly, fitted into mounting plate for easy assembly. Designed to fit specific space envelope for military aerospace application.

Please contact our sales office to discuss your specific filtering requirement. We would be pleased to provide a technical and commercial proposal.

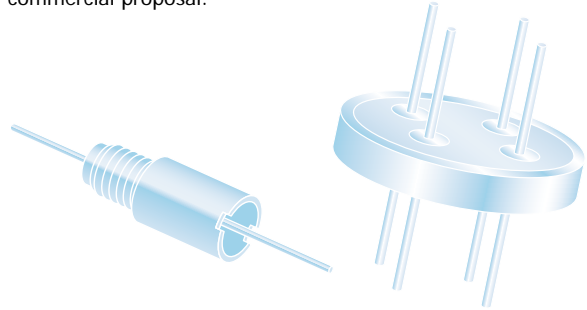

Special discrete filters to match your specific requirements

Manufactured to fit the customers specific requirements, electrical characteristics and space envelope. We can offer design solutions to meet your requirement or develop customer designs into production reality.

- **Example 1** - Battery terminal filter to meet precise environmental requirements and provide flat pin contact surface for connection to spring contacts on clip-on batteries. Designed to fit customers' space envelope and meet specific electrical parameters.
- **Example 2** - Special SFSSC disc-on-pin decoupling stub filter for military application. Contact pin terminating inside discoidal and insulated from non pin side. Assembled with high melting point solder to allow customer to solder into panel.

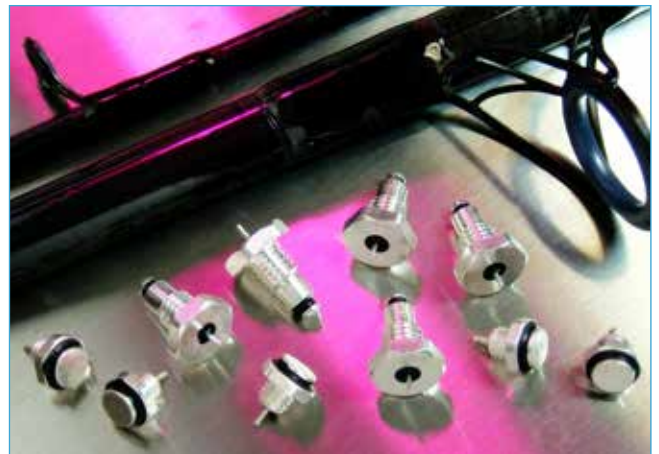
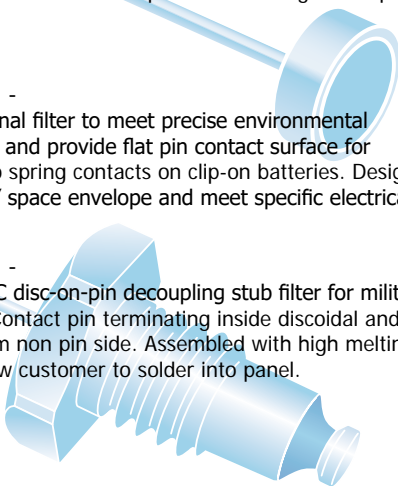

Filters for Hi-Rel Applications

Introduction

Knowles is experienced at providing products for the most demanding applications:

- Space projects
- Automotive - AEC-Q200 qualified
- Military and Civil aviation
- Motorsports - F1 and World Rally
- Oil/Downhole/Industrial
- Rail
- Medical

Knowles product qualifications include AEC-Q200 and space grade planar arrays and filters.

Special finishes (eg. Sn/Pb) are available for exempt applications such as military and space. Please contact our Sales Office for further details.

Surface Mount Filters

The surface mount C filter (E01 & E07), Pi filter (SBSPP) and X2Y Integrated Passive Components (E03) are all available with Knowles FlexiCap™ (standard solderable proprietary flexible epoxy polymer termination material).

FlexiCap™ advantages

- Solves cracking problems caused by excessive mechanical stress
- The polymer allows greater degrees of Pcb deflection during de-panelisation, typically twice that of standard capacitors
- Permits more stress to be placed on components when using large through hole parts, eg. transformers, connectors, heatsinks
- More resistant to cracking during temperature cycling
- No degradation in electrical performance
- Capacitors with tin-lead termination are also available with Knowles FlexiCap™ technology

The following are qualified to AEC-Q200:

- Surface Mount 'C' Filter (E01 & E07 range)
- X2Y Integrated Passive Components (E03 range)

Resin Sealed Ceramic based Panel Mount Filters

Designed and manufactured to meet or exceed the requirements of MIL C 15733 and MIL C 28861. The test methods are in accordance with MIL STD 220 and MIL STD 202:

- Insertion loss
- Solderability
- Bump and vibration
- Temperature cycling
- Humidity
- Temperature rise under dc load

Special test requirements can be accommodated e.g. 100% burn-in.

Discoidals and Planar Arrays

Knowles were instrumental in delivering the standard for space approved planar arrays which includes Scanning Acoustic Microscopy (SAM) testing.



Additional Resources

Application Notes

AN0001 - FlexiCap™ termination

Details of the FlexiCap™ termination, which helps prevent mechanical cracking of multilayer chip capacitors.



AN0011 - Solder alloy choice and stress release cracking in through hole ceramic capacitors

Solder alloy considerations when using through hole ceramic capacitors to minimise stress cracking.

AN0014 - X2Y Balanced Line EMI chip reliability and performance data

X2Y Component reliability and performance data.

AN0018 - Suppression for DC motors using X2Y

The application of X2Y chips for EMI Suppression in DC motors.

AN0028 - Soldering/mounting chip capacitors, Radial Leaded capacitors and EMI filters

This gives guidance to engineers and board designers on mounting and soldering Knowles products.

Technical Articles

Surface Mount filter article

An introduction to Surface Mount EMI filtering and some of the filter components available.

Advances in Surface Mount filtering technology

New integrated passive components for EMI suppression filtering.

FlexiCap™ article

An introduction to FlexiCap™ and how it reduces mechanical cracking on PCB's.

Available Sample Kits

A variety of sample kits are available from Knowles to help designers and EMC engineers to select the most suitable component for any particular application.

- 115Vac 400Hz Capacitors
- AEC-Q200 Capacitors
- FlexiCap™ Capacitors
- High Voltage FlexiCap™ Capacitors
- IECQ-CECC capacitors
- X2Y - Integrated Passive Components
More information on X2Y products is available from www.X2Y.com
- Non magnetic Capacitors
- Safety Certified Capacitors
- StackiCap™ Capacitors
- Surface Mount EMI Filters
- Ultra-low ESR Capacitors



DLI•JohansonMFG•Novacap•Syfer•Voltronics



Please visit the Knowles website for further details, or contact the Sales Office.

Product Safety Information



Please read in conjunction with the product data. Failure to observe the ratings and the information on this sheet may result in a safety hazard.

1. Material Content

The electronic components described in this catalogue are not considered to be chemical substances or mixtures within the meaning of the CLP (Classification, Labelling and Packaging) Regulation, and therefore there is no regulatory requirement to supply safety data sheets or hazard warning labels. However the following descriptions of the materials used may be useful when considering safety precautions and waste disposal methods.

All Knowles components, unless by customer request, fully comply with the REACH (Registration, Evaluation, Authorisation and restriction of Chemicals), WEEE (Waste Electrical and Electronic Equipment) and RoHS (Restriction of Hazardous Substances) Directives, although some RoHS exemptions may be applied in respect of this. Please see the environmental area of the Knowles website for further information. Non RoHS finishes are available for most ranges by customer request and are usually alloys of tin and lead.

- a. **Ceramics:** these are blends of oxides of Barium or Magnesium and Titanium, with smaller additions of oxides of Bismuth, Calcium, Manganese, Niobium, Neodymium, Silicon and Zinc which are fired at high temperatures to give an insoluble reacted mass.
Certain legacy products for non-commercial applications may use non RoHS compliant ceramic materials including blends of oxides of Cobalt and lead.
- b. **Internal electrodes:** these are combinations of precious metals, mainly Palladium and Silver, which are relatively inert.
- c. **Terminations:** these are combinations of precious metals, again mainly Palladium and Silver, which are fused to the ceramic body by a small amount of glass. The FlexiCap™ termination contains Silver and Polymer. Both systems are totally lead free. The terminations are covered with electroplated layers of Nickel and Tin or Tin/Lead.
- d. **Assembled filter products:** The ceramic elements are soldered to copper based current carrying axial leads using solders of different alloys dependent on particular filter type. These solders are formed from the elements Tin, Silver, Indium, Lead and Copper in varying proportions dependent on alloy used. If a filter body is present it will be manufactured from steel or copper alloy and soldered to the ceramic element using the same solder alloys as described above. All metal parts are electroplated with Nickel, Silver or Gold over a Copper or Nickel undercoat. Ferrite beads consisting of Manganese Zinc Ferric Oxide and Nickel Zinc Ferric Oxide are used to increase inductance in L-C and PI type filters. Encapsulants are high purity epoxy resins with a synthetic fused silica filler. Conductive epoxies containing silver particles may be used to form electrical connections.

2. Failure Mode

The normal failure mode of the component is to become short circuit. If there is then sufficient electrical power available the component will become extremely hot. Although the ceramic and metallic components of the capacitors are non-combustible, there is a danger of ignition of neighbouring combustible materials and the encapsulation (if present). The component materials of the capacitor may also be vaporised and give off toxic fumes. In the case of MLCC the component voltage ratings must not be exceeded and it is advisable to include current limiting in the circuit design. Circuits should be designed to fail safe under normal modes of failure.

3. Handling and Storage

The components represent no health hazard when handled normally. However, during testing or circuit operation capacitors can become charged to high voltages, and may retain this charge even after the equipment is switched off. Components must be discharged before being handled.

Care should be taken when handling components not to damage either the capacitor or any encapsulation so that the risk of failure is minimised.

Ideally long term storage conditions should be temperature controlled between -5°C and +40°C and humidity controlled between 40 and 60% RH. The solderability of the component may be degraded by storage in contaminated environments.

4. Disposal

It may be worthwhile refining scrap components to recover their precious metal content if there is a sufficient quantity available. In general the disposal of electronic equipment is covered by the EU directive on Waste Electrical and Electronic Equipment which lays down measures which aim to prevent waste electronic equipment and promote re-use, re-cycling and recovery.

5. Environmental Considerations

Knowles has eliminated the use of substances that are implicated in stratospheric ozone depletion as defined in the Montreal Protocol. In addition the use of VOCs, which can lead to ozone formation in the troposphere, is reviewed with the object of minimising any emissions and eliminating the most harmful. Other elements of the company's activities are assessed to determine which areas should be given priority in order to minimise any environmental impacts.

6. Capacitor Related Documents

BS EN 60384-1

Generic Specification : fixed capacitors.

CECC 32 100

Sectional Specification : fixed multilayer ceramic chip capacitors.

BS CECC 30 600

Sectional Specification : fixed ceramic capacitors, type 1.

BS CECC 30 700

Sectional Specification : fixed ceramic capacitors, type 2.

BS EN 60286-2

Packaging of components for automatic handling.

BS EN 60286-3

Packaging of components for automatic handling.

EIA-469-C

Destructive physical analysis of ceramic capacitors.

7. Filter Related Documents

MIL-F-15733G

General specification for RFI filters and capacitors.

MIL-F-28861B

General specification for electromagnetic interference suppression filters and capacitors.

MIL-STD-220A

Method of insertion loss measurement.

MIL-STD-202F

Test methods for electronic and electrical component parts.

BS 6299:1982

CISPR 17:1981
Measurement of the suppression characteristics of passive radio interference filters and suppression components.

BS 2011:-

Environmental testing.

BS EN 60068:-

Environmental testing.

BS 2816:1989

Electroplated coatings of silver.

BS 3382

Electroplated coatings of threaded components.



Trimmers



Pulse Capacitors



Trimmer Capacitors



Half-turn Trimmers

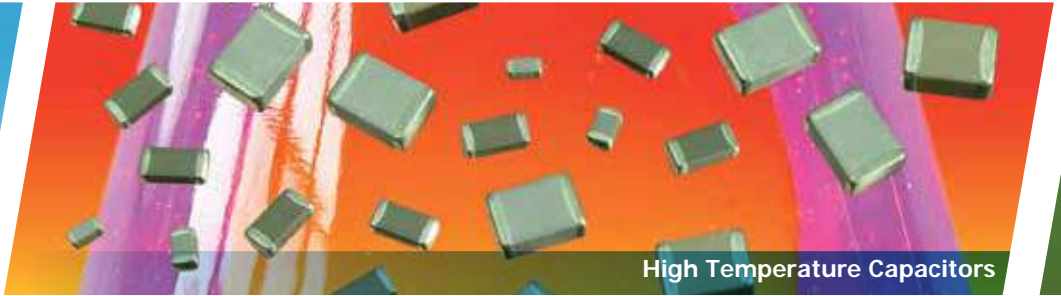

High Temperature Capacitors



Single Layer Capacitors



High Q Ultra Low ESR Capacitors

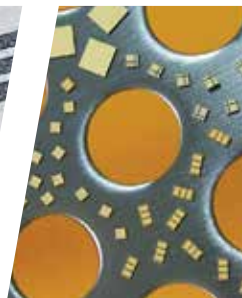

Gain Equalizers



Specialty Products



Power Dividers

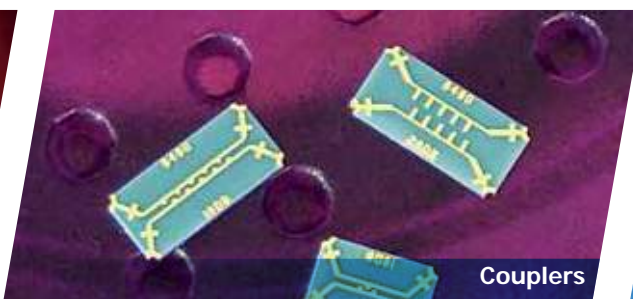

Couplers



Trimmer Ca

Other products available



Hi-Rel Products



Hi-Rel and Specialty Products



Thin Film Devices



Trimmer Capacitors

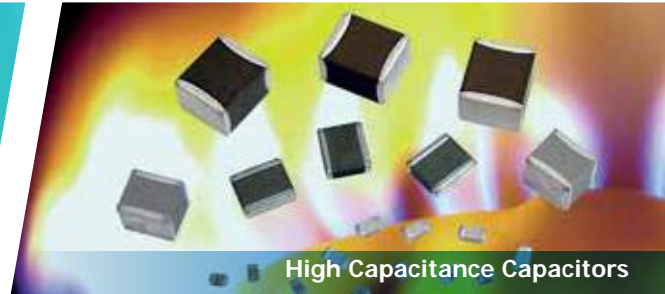

High Capacitance Capacitors

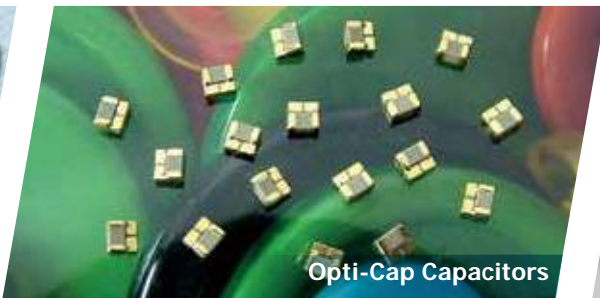

Opti-Cap Capacitors



Hi-Cap Capacitors

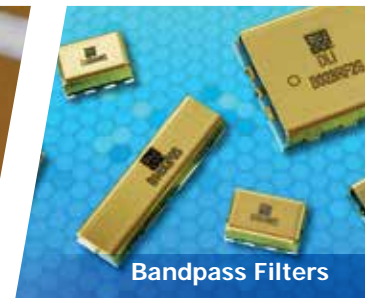

Bandpass Filters

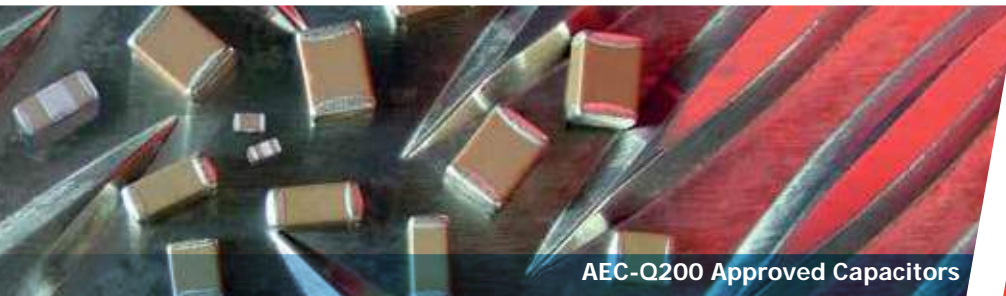

AEC-Q200 Approved Capacitors



Capacitors



Hi-Rel Tab Lead Capacitors



StackiCap™ Capacitors

from  **knowles**
DLI•JohansonMFG•Novacap•Syfer•Voltronics



knowles

DLI•JohansonMFG•Novacap•Syfer•Voltronics

Knowles Capacitors designs, manufactures and sells special electronic components. Our products are used in military, space, telecom infrastructure, medical and industrial applications where function and reliability are crucial.



Knowles (Cazenovia)
2777 Route 20 East, Cazenovia,
NY 13035 USA

Phone: +1 315 655 8710
Fax: +1 315 655 0445
KCCSales@knowles.com



Knowles (Valencia)
25111 Anza Drive, Valencia,
CA 91355 USA

Phone: +1 661 295 5920
Fax: +1 661 295 5928
NovacapSales@knowles.com



Knowles (UK) Ltd
Hethel Engineering Centre, Chapman Way,
Hethel, Norwich, Norfolk NR14 8FB

Phone: +44 1603 723300
Fax: +44 1603 723301
SyferSales@knowles.com



Knowles (Cazenovia)
2777 Route 20 East, Cazenovia,
NY 13035 USA

Phone: +1 315 655 8710
Fax: +1 315 655 0445
VoltronicsSales@knowles.com